

Castradis



Design Supplementary Planning document (SPD)

8

Shop Front Guidance

March 2017

Contents

Introduction	4	8.2 Design/ Consent/ Implement	42
		Assessing your shop front	42
Key points to think about	8	Design & Consent	44
8.1 Shop front Design Guidance	10	Planning application tool	48
The elements of a shop front	12	8.3 Mertons Town Centres	54
Your shop front in the high street	12	Wimbledon Town Centre	56
What makes a successful high street	14	Wimbledon Village	60
What makes a good shop front	16	Arthur Road	66
Advertising	18	Colliers Wood	68
What makes a good display	20	Mitcham Town Centre	72
What makes a good sign	22	North Mitcham	76
Shop fronts in new developments	28	Morden	78
Larger units & Supermarkets	30	Raynes Park	80
Temporary uses	32	Motspur Park	82
Security	34	8.4 Maintenance	84
Sustainability	36	Cleaning	84
Improving access & improving business	38	Timber Repair & Decorating	86
Do you need a new shop front?	40	8.5 Conversions to residential use	90
		The need for guidance	90
		Policy context	91
		Planning permission	91
		Design guidance	92
		8.6 Glossary	98

Introduction

The need for guidance

During the last decade internet shopping has taken an increasing market share in the UK, with online sales exceeding £116bn in 2015. Many high street retailers are experiencing the implications of this shift and are evaluating their business strategies to remain competitive.

What is unique about the high street is its distinct identity, a personal service and the convenience and flexibility of neighbourhood shopping. We know from high street customers that the visual appearance of shops and the quality of the retail offer directly impact on their decision to shop local.

The shop front is the identity of the shop - irrespective of the line of trade it pursues. It is also the single most effective marketing tool for most high street business. A well-ordered, tidy, contextual and cared-for appearance will almost always result in better business.

Every shop front is also part of a wider urban context. It impacts on the way the host building is read and it contributes to the look and feel of the high street as a whole - even when a shop is closed and at night.

Merton Council is proud of its track-record in supporting local businesses and the awards that we have won recognising our work.

Merton's town centres significantly contribute to the character of the borough. They provide employment opportunities, entertainment, are sites for cultural engagement, offer a wide range of retail and services and give a recognisable identity to a neighbourhood. Everyone living or working in Merton in one way or another has a stake in their local town centre.

Each town centre, high street or neighbourhood centre has a distinct identity, defined by the character of the existing architecture, but also by markets, events and the socio-economic context of the area. Our regeneration strategy for the next decade aims to reinforce the individual character of Merton's town centres to ensure that they provide access and opportunities for all and that they are successful and prosperous.

We are optimistic that together we can build more pleasant high streets and town centres with profitable businesses where people feel at home, like to shop, eat, buy services and be entertained.

As retail trends have changed, many small shopping parades have become unviable and sought to return to or change to residential use. This document also gives design guidance on how best to convert a shop front to residential use.

Who is the guidance for

This document is designed to be a useful guide for shop owners, developers and building owners wanting to undertake work to shop fronts and signs. It also gives guidance for new-built retail units.

The guide is aimed primarily at people who own their own shops and will be themselves responsible for its repair and economic success. As such the guidance covers a wide range of subject areas and is intended to aid owners find the most appropriate and cost effective way of keeping a good quality shop-front and successful business. Shop-fronts requiring specialist architectural work or shops owned by companies with multiple outlets are less likely to require some of the guidance, however much of it will remain relevant.

Status of guidance

This guidance applies to all shop fronts not just those in the main centres in the borough. This guidance should be read in conjunction with Merton's Borough Character study, Conservation Area Appraisals as well as planning policy documents.

Planning permission is required to install and in some cases to alter a shopfront. However we recommend that this guidance should be used whether planning permission or relevant consents are or are not required. This will help to ensure that development is respectful of the surrounding area and of a high quality design. It is worth considering employing an architect to achieve the most attractive and effective shopfront.

This Shopfront Design SPD takes account of current national and regional planning policies and guidance on town centres; as well as recognised design practices.

The below symbols appear throughout the document.



Represents a good example



Represents a poor example

Format of guidance

The guide is sub-divided into 5 sections. **Section 1** highlights the most important considerations when considering works to shopfronts and signage. This includes the components of a shop front and gives guidance on responsive shop front and signage alterations and renewals. This section also gives advice on the design of shops and shop fronts in new developments and on meanwhile uses.

Section 2 explains the practical steps to take when changing a shopfront, including information on planning applications and building regulations. And it provides a range of interactive shopfront examples which can be edited to create planning drawings as such a planning application tool which can be used in making a planning application for a range of predominant typologies in Merton's town centres.

Section 3 provides an overview of Merton's main town centres, predominant building typologies and key features of existing shop fronts and shopping parades.

Section 4 provides practical guidance on maintenance of shop fronts including cleaning and repair.

Section 5 provides detailed guidance for those considering changing their shop to residential use. This gives practical information on planning permission and design guidance on the best approach to take.

The text in this guide is printed in two colours. Text printed in black explains, analyses and contextualises. Text which appears in numbered green box gives specific guidance that we expect applicants to follow when applying for planning permission.

Changing your shop front?

Changing, updating or renovating your shop front is an important decision and if done well can help your business to advertise and brand itself and strengthen its identity on the high

street. The right design decisions can save money and time too. Below are some key principals to think about.



Key steps to improving your shop



Key things to think about

Do I need a new shop front?

Visual improvements can often be achieved through repairs and adaptations to existing shop fronts this often has a much greater visual impact than a brand new shop front - and can save money.

Security

An ill conceived & over ambitious security strategy can be expensive and in some cases encourage anti-social behaviour and have a detrimental effect on trade.

Signage

A shops branding is the first impression that customers have of a high street business. A well composed & proportioned font, layout and colour palette will help customers recognise your brand.

Display

The shop display is part of your branding and an important marketing opportunity. Closing off a shop front with posters, vinyl or placing the backs of shelves against it rarely works. A well-ordered display and a clear view into the shop invites passing trade.

Sustainability

Choosing materials for your shop front is a very important decision. Materials that are easy to change and repair will reduce maintenance costs and allow for re-branding.

Forecourts

Occupying the forecourts in front of your business can help to create a lively and bustling high street and also advertise and attract new customers - but may require a licence.

Historic features

Does your shop have any historic features, cornicing, corbels, pilasters or an entire historic shop front? Historic features add to the character of the shop front and should be retained & repaired and if appropriate re-painted for maximum impact.

Is your building listed?

If your shop is in a listed building or a conservation area you will likely need extra design guidance from an architect and/or the councils planning department. (Caution: altering a listed building without planning consent is a criminal offense)

8.1. Shop front design guidance

The elements of a shop front

8.1.1 Many buildings along Merton’s high streets date back to the Victorian era. Traditionally shops formed the ground floors of terraces with the upper floors used for residential, such as Leopold Road.

8.1.2 Many Victorian shop fronts feature advanced functional and technological characteristics, including natural ventilation strategies and wooden security shutters. But the Victorians were also conscious of classical proportion, alignment and the use of ornamentation to define and frame sections of the building.

8.1.3 Pilasters give a rhythm to the terrace and ensure legibility by framing the individual businesses along the road.

8.1.4 Cornicing marks the top edge of the shop front and distinguishes the shop visually from the upper building facade.

8.1.5 Stall riser are sometimes made from brick or glazed brick or wooden panelling. They provide protection to the shop front at street level and a solid base for a raised display on the inside of the shop front.

8.1.6 Painted timber signs are used to display the shop name. They are easily adaptable and repairable and can be re-branded by subsequent tenants without the need for a new sign.

8.1.7 Timber window frames were traditionally made from good quality timber and can be repaired or re-painted to reflect the corporate identity of the individual shop.



Key elements of a traditional shop front

- | | | |
|---------------------------------------|--------------------|----------------------|
| 1 - stall riser | 5 - glazing | 10 - awning box |
| 2 - pilaster plinth / base | 6 - timber mullion | 11 - projecting sign |
| 3 - pilaster shaft | 7 - timber transom | 12 - timber fascia |
| 4 - pilaster corbel / console bracket | 8 - fanlight | 13 - cornice |
| | 9 - awning arm | 14 - render or brick |

If your shop front has any of these features which have been lost or damaged, proposals should include their repair or re-installment.

8.1. Shop fronts design guidance

Your shop front in the high street

8.1.8 No shop front exists in isolation. When designing a new shop front or new signage, careful consideration needs to be given to the host building, the host terrace and the high street as a whole. Pilasters and cornicing are common features which mark the party wall and separate one unit from another. They help to introduce a sense of order and proportion along continuous terraces.

8.1.9 Pilasters appear on most late 18th, 19th and early 20th Century high street properties in Merton. Pilasters give a rhythm to the terrace and ensure legibility by framing the individual businesses along the road. They often presented an opportunity for lavish decoration and an exquisite material palette including glazed terracotta, ornate stucco work, wood carving and polished granite.

8.1.10 To maintain legibility along high street terraces, pilasters should be kept free of services ducting, pipes, advertisements and signage. They should not be 1/2 painted in different neighbouring colours/ styles. They are one of the most important elements of the building and shopfront.

8.1.11 Many 19th and early 20th Century properties feature cornicing above the shop sign.

8.1.12 The cornicing frames the shop front and distinguishes the shop visually from the upper building facade. The bottom of the console bracket defines the appropriate depth of the fascia. Together they set a consistent height of signs along the terrace.

8.1.13 The Council will resist proposals that involve the removal or covering-up of pilasters and cornicing and signs that go below the bottom of the console bracket.

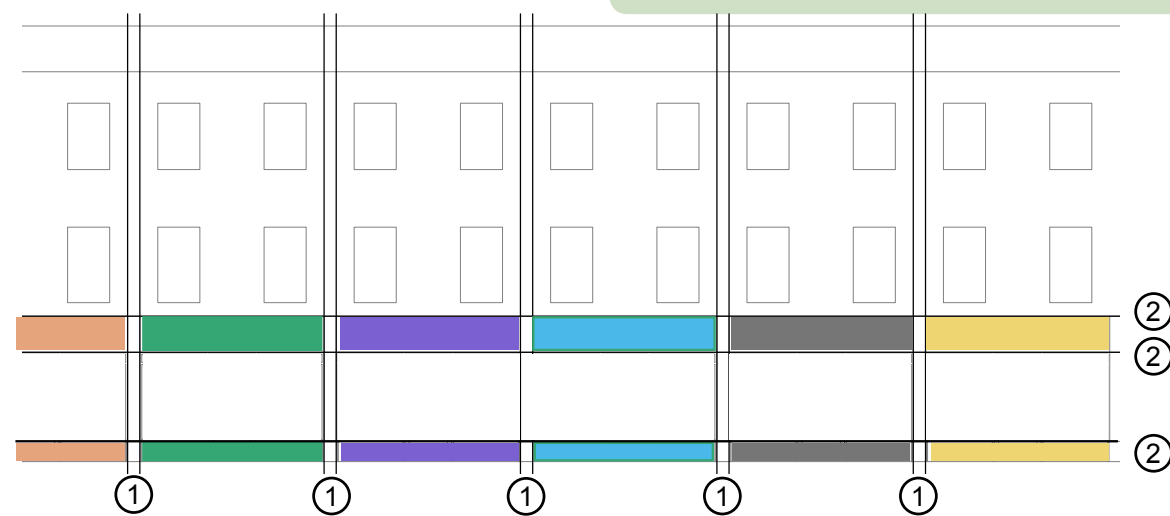

1 - vertical rhythm defined by pilasters
2 - horizontal rhythm defined by stall riser, fascia and cornice

To maintain legibility along high street terraces, pilasters should be kept free of services ducting, pipes, advertisements and signage.

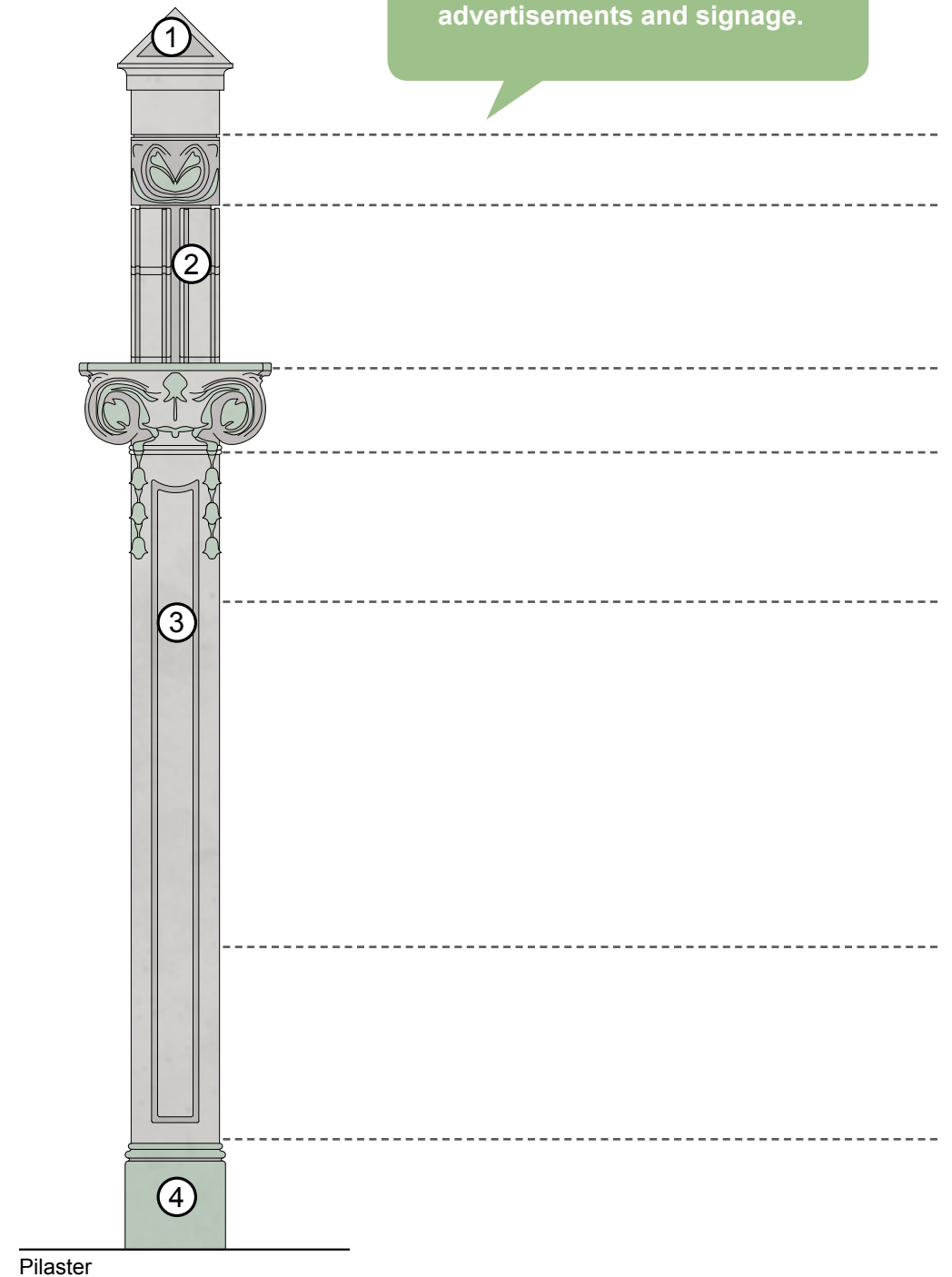

1 - corbel / console bracket
2 - capital
3 - shaft
4 - plinth / base

8.1. Shop front design guidance

What makes a successful high street?

8.1.14 Successful high streets are individual and specific and can successfully adapt to regular change.

8.1.15 A high street is constantly responding to change, it is highly dependent on the changing socio-economic context of the local neighbourhood. To take account of these changes businesses need to firmly commit themselves to a gradual but constant process of renewal.

8.1.16 One of the high street's most treasured assets is the individuality and diversity of local businesses. The high street has something to offer, that's different to supermarkets and shopping centres: a unique identity and a distinct character that's grown out of a very specific economic and social context.

8.1.17 Shop front improvements need to strike a careful balance between business needs, the building they sit within and the appearance & coherence of the street as a whole



Shop front improvements in High Road Leyton by Jan Kattein Architects

8.1. Shop front design guidance

What makes a good shop front?

8.1.18 Every shop is different. Diverse locations and a varying customer base call for individual design solutions. However, in all instances a good shop display clearly expresses the shop's identity and purposes through simple design and

graphics and an attractive display and overall look. The following are examples of great shop fronts Where the proportions, colour, advertising, have all been carefully considered and designed, and finished to a high quality.



Cath Kidston in Wimbledon Village has a simple colour palette featuring a light blue background with high-contrast lettering to the main fascia sign. The lettering is well-proportioned in comparison to the overall shop sign and there is a clear hierarchy between the shop name and secondary information. The sign appears bulky.



Pride and Groom and Motor Spares in Nunhead share the same shop front. 2 shops sharing the same premises can still have their own identity and branding. The width of the sign matches the width of the shop front. Architectural features like pilasters and corbels frame the shop front and unify the shop. Festoon lights illuminate the fascia sign at night, but they also give the shop a distinct appearance.



Interior lighting at Al Bader in South Leyton advertises the business by allowing the public to look in from the street. Openable windows engage with the pavement in the summer. The entrance door is located where it is most visible, at the corner.



Albert & Francis in Leyton provides outside seating. Apart from extra covers, outside seating and a bustling street scene can attract new customers. Large open windows and a carefully conceived interior give an inviting appearance. A chalkboard menu can be customised and feature seasonal offers.



Network in Nunhead has a modern shop front which gives a clear view into the shop. The sign graphics are simple, using two contrasting colours and two fonts. The pots in the forecourt complement the shop front design. A projecting sign is integrated with the fascia sign.

8.1. Shop front design guidance

Advertising

8.1.19 Some shops use third party advertising as a source of revenue. However attractive potential additional income sounds, third part advertising almost always distracts from the primary retail offer, making it more difficult for customers to find your business and to understand your offer.

8.1.20 Notices and posters on windows are commonly used to advertise new services and special offers. Too many notices and/or a poorly conceived arrangement of notices in the window can have a messy appearance and confuse your customers. Notices and posters also cut out daylight, creating dead frontages that make the shop interior appear dark and unattractive from the outside.

8.1.21 There are alternatives to affixing paper on the inside of the glass. Consider the use of advertising set back from the glass. For shops that have regular/changing special offers, consider a chalkboard as part of the shop display. To display posters, consider a suspended acrylic poster holder. Digital displays or pegboard lettering is an effective means to capture customers' attention.

8.1.22 When fixing vinyl to the inside of the glass, don't apply opaque sheets, instead use individually cut out lettering or graphics to allow light and views in.



10% of the shop above is covered with vinyl graphics. The shop front is instantly more open and inviting as customers can physically see into the shop. The shop name is simple and bold, and any third party advertisements are displayed in a designated area.



66% of the shop above is covered in third party advertisement creating a hostile shop front in which isn't inviting to customers.

8.1. Shop front design guidance

What makes a good display?

8.1.23 The shop display is part of your branding and an important marketing opportunity. Closing off a shop front with vinyl or placing the backs of shelves against it rarely works. A well-ordered display and a clear view into the shop invites passing trade. Customers are more likely to come into a shop they can see into which that looks busy, open and welcoming.

8.1.24 A changing display for seasonal events will engage new customers and entice regulars to have a look at the range of goods on offer.

8.1.25 Where merchandise is displayed on the pavement, a well thought-out display strategy will save staff-time setting-up in the morning and protect merchandise from the weather. A pavement licence may be required for items placed outside the shop.

8.1.26 Display lighting is an effective means to advertise a shop. Ensuring that the inside is brighter (or just as bright) as the outside on an overcast day or in the evening makes the shop look inviting. A carefully thought through lighting strategy will ensure that there is no glare and that customers are not blinded. There are two types of lighting, display lighting and feature lighting which can be combined for maximum effect.

8.1.27 With display lighting, the light source is commonly concealed, illuminating goods displayed in the shop window. Spots or trough lighting can be used for display lighting.

8.1.28 With feature lighting, the light source is visible. Common types of feature lighting include chandeliers, lamp shades and suspended lightbulbs. LED light fittings in combination with an automatic timer switch will minimise electricity use.

Table 01



Select items and services that are best promote your business, that entice people in off the pavement.

Consider how the branding and colours of your display can complement the branding of your fascia signboard

Consider a pavement licence and use your forecourt to create a lively display and attract new customers.

Maintain and update your display with new products and seasonal offers.

Use carefully considered lighting to continue advertising when you business is not open.



Do not placing shelving and storage right up again your glazing and block views and light into the shop.

Avoid cluttering your display with too much information. A long list of available services will often be ignored by passers by.

When utilising forecourts, do not block peoples way or make it difficult for customers to find their way through into your shop. Carefully consider how much you are displaying. Less often is more.

The shop display is part of your branding and an important marketing opportunity.



Chalkboards are a good solution for shops with changing offers.



A clear view through the shop front into a well-stocked shop is the most direct kind of advertising.



Suspended displays accommodate changing notices and posters.



A tidy and well thought-out fruit and veg display makes a good impression and helps with stock management.



8.1. Shop front design guidance

What makes a good sign?

8.1.29 A shop's branding is the first impression that customers have of a high street business. A well-composed and proportioned font, layout and colour palette will help customers remember and recognise a brand. Different fonts will have different connotations, different colour palettes generate different associations. Pilasters and stucco detailing should be consistent across the terrace. In most cases, stucco will be painted white.

8.1.30 To ensure that a shop sign is clearly legible, the sign-writing should stand in contrast with the background colour. A muted background colour with saturated text makes the text stand out. A saturated background colour with muted text makes the text recede.

8.1.31 It's often best to limit the number of colours. Working with shades of the same colour is the easiest way of providing your shop front with an appealing colour scheme. A palette of 3 muted shades can be combined with a punchy colour or black for the text.

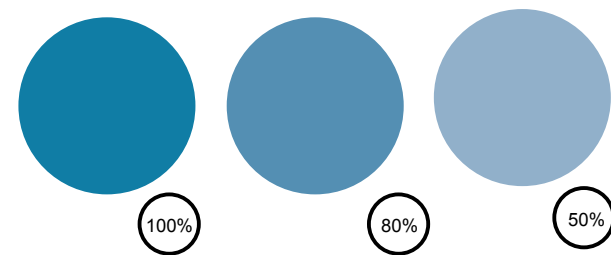

Gradients of the same colour.

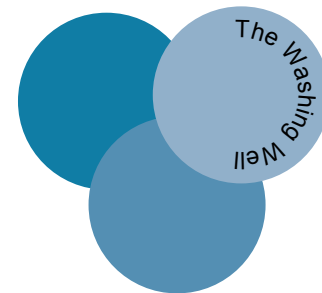

8.1.32 Bigger is not always better. A sophisticated and proportionate font size will ensure that your shop name communicates well. Overtly large letters are hard to read from the pavement. Fascia lettering of between 250mm and 300mm will read well from street level and from across the road if the correct font and colour are selected. Where the size of the fascia is defined by the building typology or detailing, the font size should be proportionate to the fascia.

8.1.33 A carefully considered hierarchy of lettering on the fascia sign will ensure that the right message gets across. The shop name should always be the largest font size. Other information like telephone numbers, house numbers or a website address can be added to the sign in a smaller font.

8.1.34 Consider combining a fascia sign with vinyl lettering on the glazing to give additional information like opening hours or services offered. Vinyl lettering is particularly useful where fascias are narrow or for shops with changing offers.

Less is more. The amount of text/graphics on a sign should be limited to the most important information. Overloading the sign with information will detract from the key message you want to get across.



8.1. Shop front design guidance

What makes a good sign?

8.1.35 Careful consideration of the colour palette for a new shop sign and shop front help to celebrate the uniqueness of the business. Beyond the usual primary colours, there are thousands of shades available even from the most common paint or vinyl graphics manufacturers. Powder coated aluminium shop fronts are usually supplied in a wide range of industry standard 'RAL colours'.

8.1.36 Brighter is not always better. A considered palette can give the impression of sophistication and unusual and individual colours will make a shop stand out amongst its competitors.

8.1.37 Below is a small selection of exclusive colour combinations complete with their CMYK colour values, (CMYK stands for cyan, magenta, yellow + black and it is used in digital image processing and printing) but many others are appropriate.

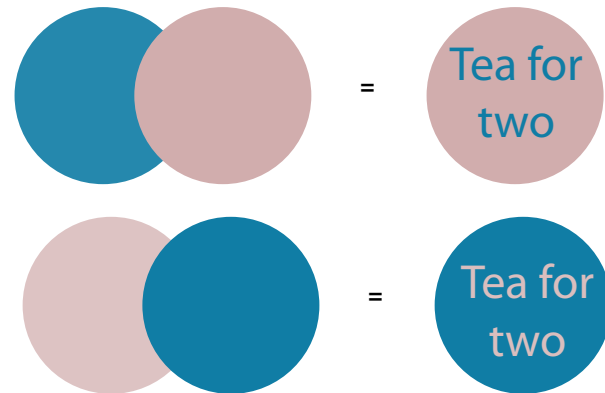

Contrast between sign writing and background is essential to ensure legibility

8.1. Shop front design guidance

What makes a good sign?

8.1.38 A shop's sign should be customisable to accommodate change in branding, use or ownership, through the use of low-tech construction methods that allow alteration by local and affordable tradespeople.

8.1.39 Fascia sign should be kept uncluttered to keep information about your business clear to customers. For projecting signs consider using minimal steel brackets fixed to the fascia board to serve a hanging element that is specific to your shop's branding.



✓ Cafe Venetia has a unique and simple branding. The sign is made from timber and the projecting sign bracket is minimal and well-proportioned.



✓ Pak Butcher has a simple colour palette. The shop name is displayed in large letters with secondary information shown in a smaller font. Iconography is combined with text to make the sign more legible.



✓ The Croydon Community Centre has a simple timber sign with an applied 3-dimensional element.



✓ Gina has a simple suspended sign affixed to the fascia board.



✓ AG Flowers has a classic sign layout featuring the shop name, house number and telephone number. The colour palette ties in with the shop front and stall riser.



✓ J. Clark & Sons have a glass sign in a hardwood frame.

8.1. Shop front design guidance

Shop fronts in new development

8.1.40 Good shop front design in new development can have a significant impact on the quality and liveliness of public spaces and the high street environment. The following principles should inform the design of new shop fronts.

8.1.41 High streets are highly dynamic retail environments. Large retail units should be designed to allow for sub-division and to accommodate a range of different business types.

8.1.42 New developments should provide a diverse range of types and sizes of retail units to accommodate different types of businesses. Prime, high-street facing retail should be complemented by secondary retail to ensure that new businesses and specialist businesses have access to affordable retail space. Merton Council has made it a priority to improve its appeal to new and innovative businesses. Proposals for retail space that can accommodate start-ups, newcomers and specialist businesses will be supported.

8.1.43 All new retail space should be designed to be outward-facing with active frontages and displays. Entrances to retail spaces should be at regular intervals. Long and continuous retail frontages without doors are not acceptable. Inward facing retail space that turns it's back onto the high street will not be supported. Large shops like supermarkets or national chains that are unable to make use of window displays should consider sharing retail spaces with smaller retailers, cafes or services providers who can maintain an active frontage onto the high street. Where appropriate openable shop fronts with counter-folding doors are encouraged (see diagrams below).

8.1.44 Shop signage should be considered an integral part of any design proposal for a new retail unit. Signage strategies should be devised to cater for the short, long and medium term, allowing for re-branding and customisation. Specific and inflexible signage solutions are not sustainable in the long term and when shops change.

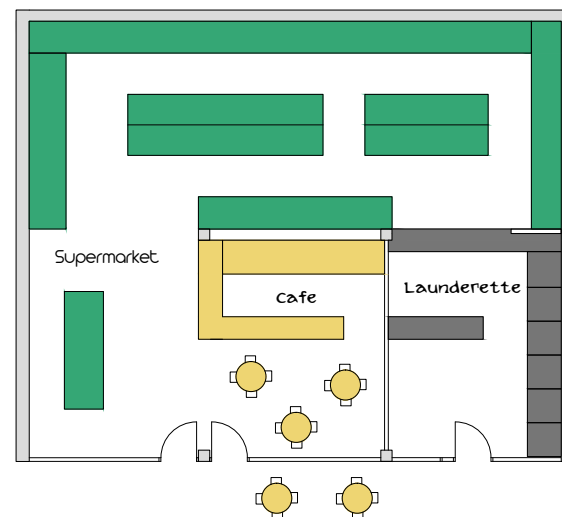
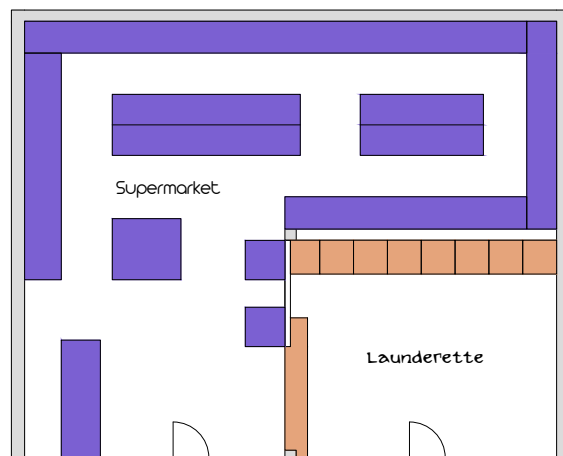

Good shop front design in new development can have a significantly impact on the quality and liveliness of public spaces and the high street environment.

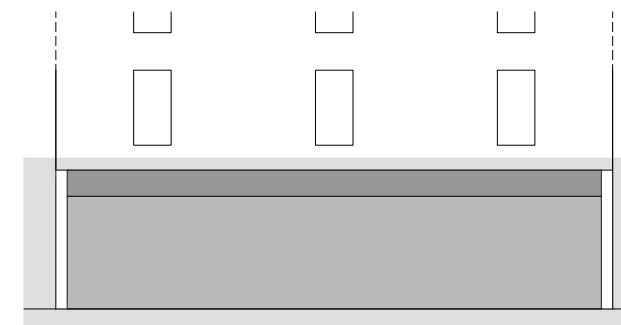

continuous retail frontages without doors are inflexible and turn their back to the high street

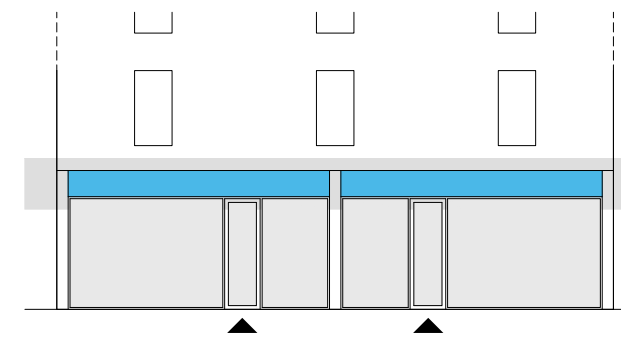

large retail frontages should be broken up and feature entrance doors at regular intervals.

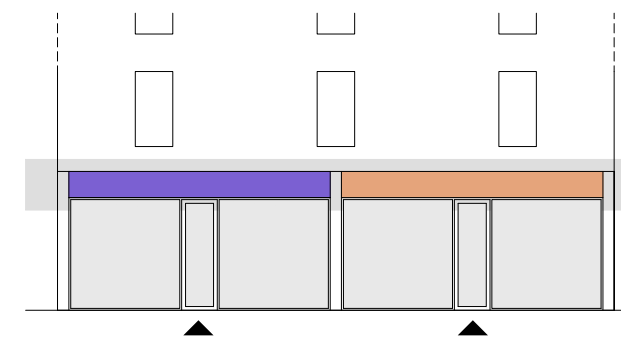

large retail spaces should be designed so they can be sub-divided in the future

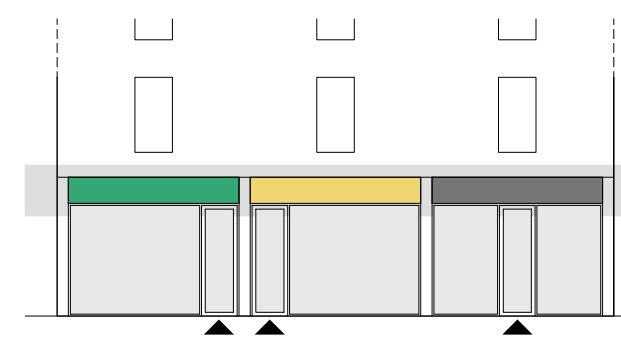

new developments should feature a range of retail units, including smaller units and units for start-ups

8.1. Shop fronts design guidance

Larger shops & supermarkets

8.1.45 Supermarkets that turn their back onto the high street by blocking out windows fail to make a positive contribution to the public realm. Shop fronts should positively address the public space by

opening up windows so that pedestrians can clearly see into the shop. Where required, awnings can be used to protect merchandise from direct sunlight.



Cooperative: Raynes Park



Limited use of vinyls and advertisement boards so that the shop windows are open.



Sainsbury's: Martin Way



Limited use of vinyls and advertisement boards so that the shop windows are open.



Poundland Mitcham



Expansive Opaque vinyls block all light and views into the space, creating a dead frontage the does not look inviting to customers.



Sainsbury's Raynes Park



This shop poorly considered the internal layout of its store. By locating offices and shelving behind windows, it has been forced to cover these openings and close itself off from the public space.



Morrisons Wimbledon Town Centre



This supermarket blocked out 50% of its shopfront and is preventing the public / potential customers from seeing in.

8.1. Shop front design guidance

Temporary uses

8.1.46 Empty shops communicate an air of neglect, accelerate the dilapidation of old buildings and cost money.

8.1.47 Temporary interventions or short lets can help vacant shops to contribute to the vibrancy of the high street in the short term and whilst a long-term tenancy is being arranged.

8.1.48 Pop-up shops and meanwhile uses are a good way to test new retail concepts and establish innovative businesses. Often a new business first trailed in a pop-up shop will be able to take on a permanent lease in the area, helping to diversify and re-invigorate the high street.

8.1.49 A landlord with a vacant or hard to let premises, can expect a short term/pop-up tenant to pay utility and Council tax bills and keep the premises safe and secure.

8.1.50 The Council will support landlords of empty premises wanting to set-up a pop-up shop. The following websites specialise in linking landlords of vacant business premises with short let tenants.

www.cu-cu.co.uk

www.appearhere.co.uk

www.vacantspaces.co.uk



The Nunhead Pop-up shop was run by Southwark Council with a rolling tenancy for local entrepreneurs.

8.1. Shop front design guidance

Security

8.1.51 Security is paramount and should be at the heart of any design strategy for a new shop front. An ill-conceived and over-ambitious security strategy is expensive, can encourage anti-social behaviour and have a detrimental effect on trade.

8.1.52 External roller shutters have a hostile appearance on the high street. Protruding shutter boxes can obscure shop signage - even when the shutter is open. Anecdotal advice from the Metropolitan Police states that the use of internal roller shutters help to reduce crime and anti-social behaviour on the high street. There are a range of secure and cost-effective alternatives to external roller shutters:

- a) Toughened glass is heat treated glass which is more durable than regular glass.
- b) Laminated glass is the most commonly used security glass in the UK. A composite material comprising a sandwich of 2 sheets of glass bonded together with a layer of resin. The material is completely clear. Various thicknesses are available to account for varying pane sizes and security needs. Laminated glass stays in place even if it is smashed with heavy tools.
- c) Self-adhesive security film is applied to existing glass. It is a completely clear, synthetic film which maintains the integrity of the glass. Special films applied to the outside of the glass can also protect shop glazing from being scratched or marked. Banks often use security films to protect high street branches.

d) Abrasion-resistant, clear polycarbonate sheet is up to 300 times stronger than ordinary glass.

If a roller shutter is unavoidable, the following considerations can help to save money and ensure a coherent design outcome:

- a) Can the shutter be reduced in width to only cover the door? Most burglars in the UK gain access to premises via a door and very few burglaries occur through shop windows. A roller shutter on the inside of the door will help prevent break-ins through the door whilst maintaining a visible display, advertising the shop at night.
- b) Can the shutter be set-back from the shop front? An internal shutter is protected from the elements. Weather protection can extend the life expectancy of the mechanical and electrical parts which operate the shutter. A set-back shutter allows clear view of the shop display even when the shutter is closed, advertising the shop at night.
- c) A coloured shutter will attract attention and dominate, whilst a black shutter will fade into the background, giving emphasis to the shop front and display.
- d) Leaving (low energy) light on inside the shop display at night will help to deter burglars while creating a friendly and welcoming high street appearance.

Leaving (low energy) light on inside the shop display at night will help to deter burglars while creating a friendly and welcoming high street appearance.



- 1 - solid shutters
- 2 - exterior open grilles
* Not advised, but could be accepted if replacing solid external shutters
- 3 - interior open grilles
- A - protruding shutter box
- B - internal shutter box

8.1. Shop front design guidance

Sustainability

8.1.53 Many building products including aluminium shop front systems and acrylic shop signs appear attractive due to their low capital costs but are costly or impossible to repair once they have reached the end of their fixed design life expectancy. Often these products will need to be replaced entirely, creating additional construction waste.

8.1.54 Timber shop fronts installed over 100 years ago are still in use across Merton today (see section 8.3. below). A high quality and well-maintained timber shop front can last more than a century.

8.1.55 Construction materials for new shop fronts should be of high quality and should be chosen with their whole-life performance in mind. A sustainable shop front is a shop front that is designed to be repairable and adaptable.

8.1.56 The high street is a living entity. Shop uses change, branding changes, ownership changes and security requirements change. These factors manifest themselves in the shop fronts. A shop front needs to be designed so that it can be customised to accommodate change. To ensure that the a shop front can accommodate change, it will need to be designed.

a) using low-tech construction methods that allow alteration, adaptation and adjustment by local tradespeople

b) using paints/finishes that are changeable so they can be customised with corporate colours

c) avoiding large constructional elements (internally illuminated signboxes etc.) that are very specific to a particular business in favour of more generic but customisable elements.

8.1.57 Openable fanlights can be easily integrated in a new shop front. Located at high level, they provide a secure and effective means of ventilation. An openable fanlight, sometimes in combination with a fabric awning can help to control the indoor climate and eliminate the need for costly and wasteful air conditioning.

8.1.58 If carefully considered, the positioning and specification of sign and display lighting can significantly enhance the legibility of shop display and sign at night. Brighter is not always better. Carefully positioned lighting which avoids glare and blinding will ensure that signs are clearly legible and avoid wasting energy.

8.1.59 Low energy lighting technology has advanced significantly during the last decade. LED tape, LED festoons, LED panels and LED strips have extremely low running costs and will provide maintenance free operation for many years.



above: illuminated timber fascia sign and shop front in Leyton, below cost/lifespan comparison between different materials for signs and shop fronts

Works	Material	Cost	Life Span
Shop front	Timber	£9000	more than 80 years*
	Aluminium	£4000	10 years
Fascia Sign	Acrylic Lightbox Sign	£1000	max. 10 years
	Illuminated Painted Timber Sign	£5000	more than 80 years*

* with periodic maintenance - see section 8.4. below

8.1. Shop front design guidance

Improving access improving business

8.1.60 The Disabilities Discrimination Act 1995 (DDA) provides the legislative framework by which the government seeks to ensure that all persons are treated equally - irrespective of any disabilities. A high street business would - in the context of the legislation - need to ensure that they put measures in place to provide the same services to all customers, irrespective of any disabilities.

8.1.61 Quite aside from complying with regulations and best practice, a business that's accessible to all will increase its customer base.

8.1.62 Many buildings from the 18th and 19th Centuries have a raised ground floor. This typology was mainly adopted for technical reasons and to allow sub-floor ventilation for the timber joists supporting the ground floor. Stepped entrances can create insurmountable access barriers for person with limited mobility.

8.1.63 Sufficiently wide entrance doors will ensure access for wheelchair users, mobility scooters and prams.

8.1.64 All new shops must be designed with step-free access - unless it can be demonstrated that the existing inclination of the site requires a stepped access.

8.1.65 Where a new shop front is proposed for a premises with an existing, stepped entrance, appropriate adaptation should be made to provide a ramped access in accordance with the Building Regulations.

8.1.66 Where ramped access to an existing retail unit would impact on ease of movement or would unreasonably impact on the existing retail/display space, an access statement with an alternative access strategy should be included with the planning application. Alternative access strategies may include portable ramps or automatic door openers. The width of all new shop entrance doors should comply with the provisions of the Building Regulations.

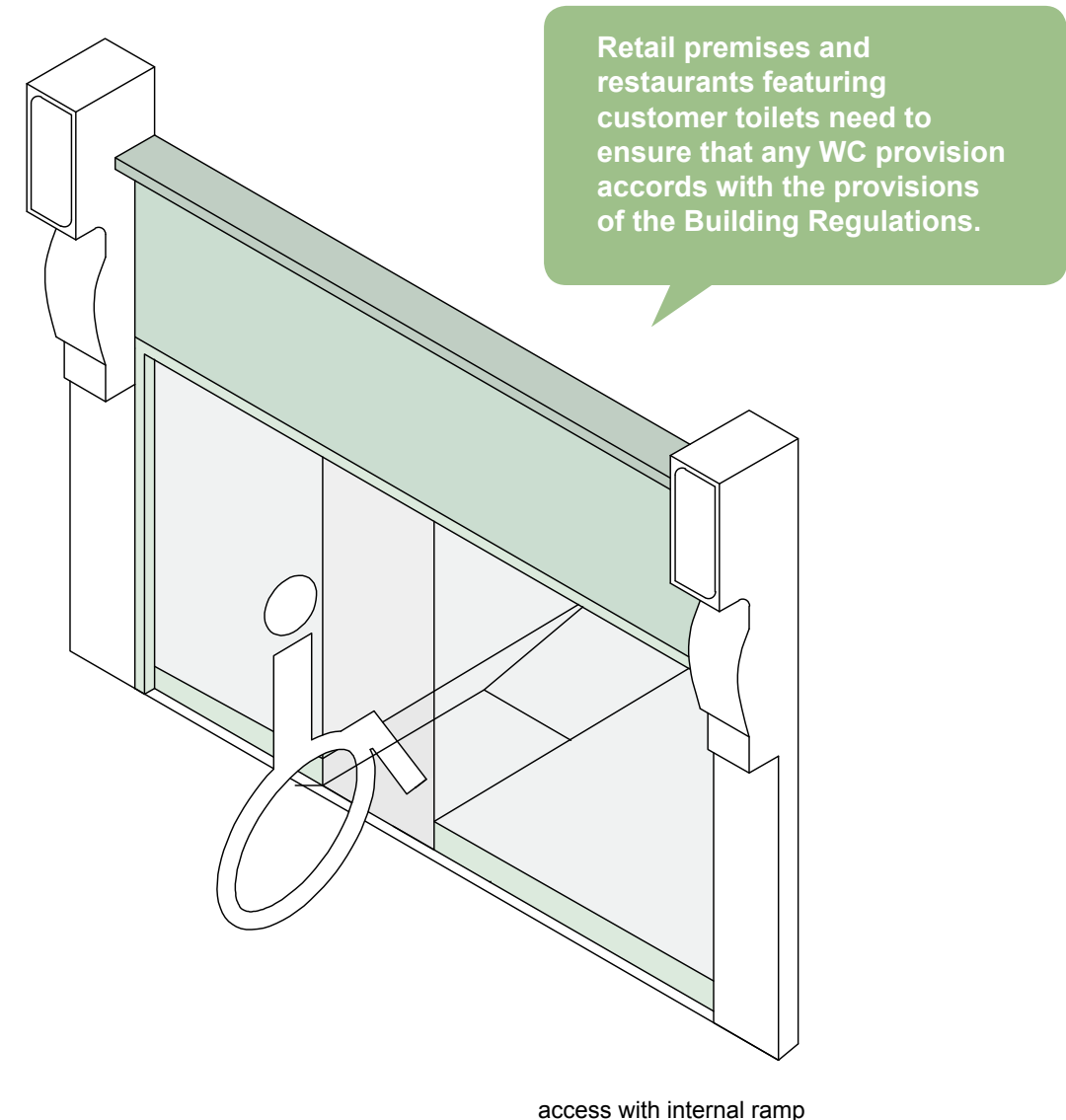

access with internal ramp

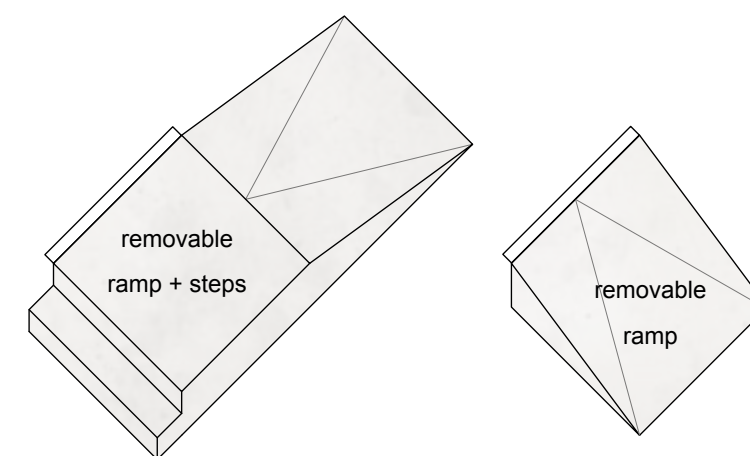

Part M of the building regulations gives guidance on the access requirements to commercial premises. See <https://www.gov.uk/government/publications/access-to-and-use-of-buildings-approved-document-m>

8.1. Shop front design guidance

Do you really need a new shop front?

8.1.67 Shop fronts have been part of British high street life for the past 200 years. The first shop fronts replaced open, shuttered trading windows with small panes of glass set into glazing bars. After excise duty on glass was abolished in 1845, many shops took advantage of larger, cheaper sheet glass to create unobstructed displays for their goods.

8.1.68 Merton has fine examples of historic and contemporary shop fronts. Wimbledon Village features a range of Victorian shop fronts with coloured fanlights and tiled, recessed entrance ways. The New Wimbledon Theatre retains examples of Edwardian shop fronts with their elegant, thin mullions and curved vitrine displays. Good contemporary shop fronts with clear lines and well-proportioned panes are also common across the borough.

8.1.69 A good quality, well-maintained shop front can last a lifetime. Visual damage to finishes and frames do not necessarily indicate the end of the design life. Carefully considering options for repair can save money and preserve the character of a historic building.

8.1.70 Even on contemporary shop fronts, visual improvements can often be achieved through repair or adaptation - rather than wholesale replacement. Sometimes, repair work to pilasters, the removal of roller shutters and the re-building of stall-risers have a much greater visual impact than a brand new shop front.

8.1.71 Historically, most shop fronts were designed to be repaired by subsequent shop owners. Individual elements of the shop front were also designed to be customised.

8.1.72 The Council will resist proposals for replacing historic shop fronts or shop fronts of particular architectural merit unless the applicant can demonstrate that all options for repair and preservation have been exhausted.

8.1.73 When determining a planning application for a new shop front, the Council will consider the longevity of the proposed materials and detailing and the ability for customisation and adaptation in the future.

Even on contemporary shop fronts, visual improvements can often be achieved through repair or adaptation - rather than wholesale replacement.



Golden Chef's Grill in Croydon opted for retaining their existing shop front, instead they invested in new branding, new signage and works to doors, uppers and stall riser.

8.2. Design, Consent, Implement

Assessing your shop front

8.2.1 Investing in a new shop front and sign is a significant decision for most high street businesses. Careful consideration must be given to business disruption, branding & design and cost.

8.2.2 New shop fronts are an investment for life. Careful consideration will help to ensure that your investment is maximised and that your business benefits. The following considerations will help you maximise your investment and comply with your statutory obligations.

8.2.3 Does your shop front have any historic features, cornicing, corbels, pilasters or an entire historic shop front? Often historic features are covered up or concealed behind surface-mounted services, superimposed signs or boarding. Historic



Historic features add to the character of the building and are a memento of times gone bye.

features add to the character of the shop front and should be retained & repaired and if appropriate re-painted for maximum impact.

8.2.4 Does your new sign need new branding? Your branding is your shops identity, it needs to be considered carefully and should represent what your business stands for. A graphic designer or branding agency can work closely with you to devise a very specific corporate identity including a letterhead, logo, packaging, colour palette, business cards and signage.

8.2.5 Often roller shutter tracks are mounted to the outside of the shop front. The tracks and boxing are subject to corrosion. Removing the shutter could give the shop front behind a new lease of life. A new internal shutter or laminated glass (fitted to the existing frame) can satisfy the most demanding security requirements - often at the fraction of the cost of a new shop front. Shutters are hardly ever attractive. If you are fitting a new shutter, choose a neutral colour like black or dark grey so that the shutter does not attract undue attention.

8.3.6 Many timber shop fronts can be repaired and re-painted. Doors can be changed to improve thermal performance and glazing can be changed to improve security - often at the fraction of the cost of a new shop front.

8.3.7 Do you have an internally illuminated box sign? Internally illuminated box signs tend to look bulky. Acrylic attracts atmospheric

pollution, ages badly and can look tatty very quickly. Is there an old timber sign behind the box sign? Often removing signboxes will expose high quality timber signs which if re-painted by a sign-painter or re-lined with plywood and then re-painted can provide a durable and elegant signage solution - at the fraction of the cost of a new illuminated signbox.

8.2.8 Is your shop front cluttered? Old, discoloured awnings, cables, broken projecting signs, and rusty satellite dishes, stickers and posters give an unsightly appearance to the best of shops. Removing clutter and tidying up lose wires combined with a fresh coat of paint to pilasters and cornicing will greatly improve appearance - at a fraction of the cost of a new shop front.

8.2.9 Is your display working? We know from high street customers that the appearance of shop displays significantly impacts on their perception of a high street business. A tidy and well-ordered display is a great means to advertise a shop. Cluttered displays can deter passing trade, customers are more likely to enter your shop if they can see in. At night or on a dark winter afternoon, good display illumination advertises the goods on offer and shows that you are open for business. Sorting out your display can greatly enhance the appearance of your shop - at a fraction of the cost of a new shop front.



This timber shop front is 100 years old and will last another century if it is maintained, repaired and re-painted regularly. The set-back entrances provide shelter before entering or exiting the building.

8.2. Design, Consent, Implement

Design and Consent

8.2.10 If you are replacing your shop front or sign, the right design can bring long-term benefits to your business. Employing an architect or competent designer will help to ensure that:

- your offer is clearly legible from the street, by day and by night;
- that the appearance of your shop addresses the customers most likely to spend money on your goods and services;
- you solve practical and operational problems; maximise display space and meet security needs
- that the proposals comply with relevant regulations and standards
- that the design is carried out to a technically competent standard to perform well and last a long time

8.2.11 You can find a registered architect at www.arb.org.uk. Depending on the nature of the work that you are undertaking you may require planning permission, listed building consent, advertisement consent and/or building regulations approval.

Planning

8.2.12 The following works will require planning permission:

- replacing a shop front
- Installing an awning may require planning permission or it may require advertisement consent
- installing an external roller shutter
- changing the use of your shop

Check <http://www.merton.gov.uk/environment/planning/planningapplications/planningforms.htm> for further information on planning requirements and forms.

8.2.13 The interactive patternbook in the appendix of this document provides templates to help generate planning drawings for some of Merton's more common building typologies.

Listed Building Consent

8.2.14 Most works to listed buildings will require planning permission and listed building consent, including internal alterations. Check <https://historicengland.org.uk/listing/the-list/> to see if your building is listed. Check http://www.merton.gov.uk/environment/designandconservation/listed_buildings.htm to see if your property is locally listed by Merton Council.

Advertisement Consent

8.2.15 The display of adverts is controlled by the Town & Country Planning (Control of Advertisements) Regulations 2007 (SI 783). The Department for Communities and Local Government (DCLG) has also published relevant guidance: Outdoor Advertisements & Signs: a guide for advertisers, June 2007. A range of advertising does not require consent and these documents should be referred to, to establish whether consent is needed. The table opposite gives further guidance on what type of work requires planning permission or advertisement consent. If you are still unsure please contact the Council or consult the detailed regulations.

Shop-fronts and Signs - What Requires Consent

	Generally	Conservation Area	Listed Building
Shop-fronts			
Installation of a new shop-front, or an alteration which materially changes the appearance of the building	PP	PP	LB PP
Demolition or removal of a shop-front or its surround, wholly or in part		PP	LB
Signs			
Internally or externally lit sign	AC	AC	LB AC
Non-illuminated sign where individual lettering is over 0.75m (0.3m in Area of special Control of Advertisements)	AC	AC	LB AC
Non-illuminated sign where any part of it is over 4.6m above ground level (3.6m in Area of special Control of Advertisements)	AC	AC	LB AC
Non-illuminated sign where any part of the sign is higher than the cill of any first floor windows	AC	AC	LB AC
Non-illuminated sign on a shop wall which does not contain a window	AC	AC	LB AC
Display of any sign not described above			LB
Blinds & Grilles			
Erection of a fixed canopy or blind	PP	PP	LB PP
Erection of a retractable canopy or blind			LB
Erection of fixed roller shutters or grilles	PP	PP	LB PP
Erection of removable shutters or grille (internal)			LB
Erection of removable shutters or grille (external)	PP	PP	LB

- PP Planning Permission Required
- AC Advertisement Consent Required
- LB Listed Building Consent Required

8.2. Design, Consent, Implement

Design and Consent

Planning Policy

If planning permission is required, then there are a number of planning policies that will be relevant in deciding on the most appropriate design. The policies will be applied in order to assess whether consent should be granted. These policies are part of the council's Local Plan and are contained in the Core Strategy and Sites and Policies Plan. The relevant policies are:

Core Strategy

- CS 2 e Mitcham
- CS 14 Design

Sites and Policies Plan

- DM R1 b) Location and scale of development in Merton's town centres and neighbourhood parades
- DM R3 Protecting corner/local shops
- DM R4 Protection of shopping facilities within designated shopping frontages
- DM D2 Design considerations in all developments
- DM D3 Alterations and extensions to existing buildings
- DM D4 Managing heritage assets
- DM D5 Advertisements
- DM D7 Shop front design and signage

Building Regulations

8.2.16 The building regulations set standards by which certain works have to abide to ensure that they are safe, inclusive and sustainable. The applicant has to ensure their work/development meets the building regulation. It is not required that you

use London Borough of Merton building control, you can also use other approved inspectors. The following works are likely notifiable under the building regulations.

- structural works
- replacing glazing/shop fronts
- re-configuration of entrance doors
- works to separating walls or floors/ceilings
- drainage works
- new roof
- changing the use of your shop

Notifiable works carried out without building regulations approval often invalidate the building insurance, will make it difficult to sell your property in the future and are subject to enforcement by the local authority.

8.2.17 The diagram on the previous page explains the shop front improvement process and associated timescales.

Planning application tool

8.2.18 We have a number of building typologies along Merton's high streets in Mitcham Town Centre, Mitcham London Road, Wimbledon Town Centre, Colliers Wood, Morden & Raynes Park already drawn up. To make the planning application process easy, check from the thumbnails on the following pages if a drawing of your building is available and click on the image to auto-generate planning drawings for your property.

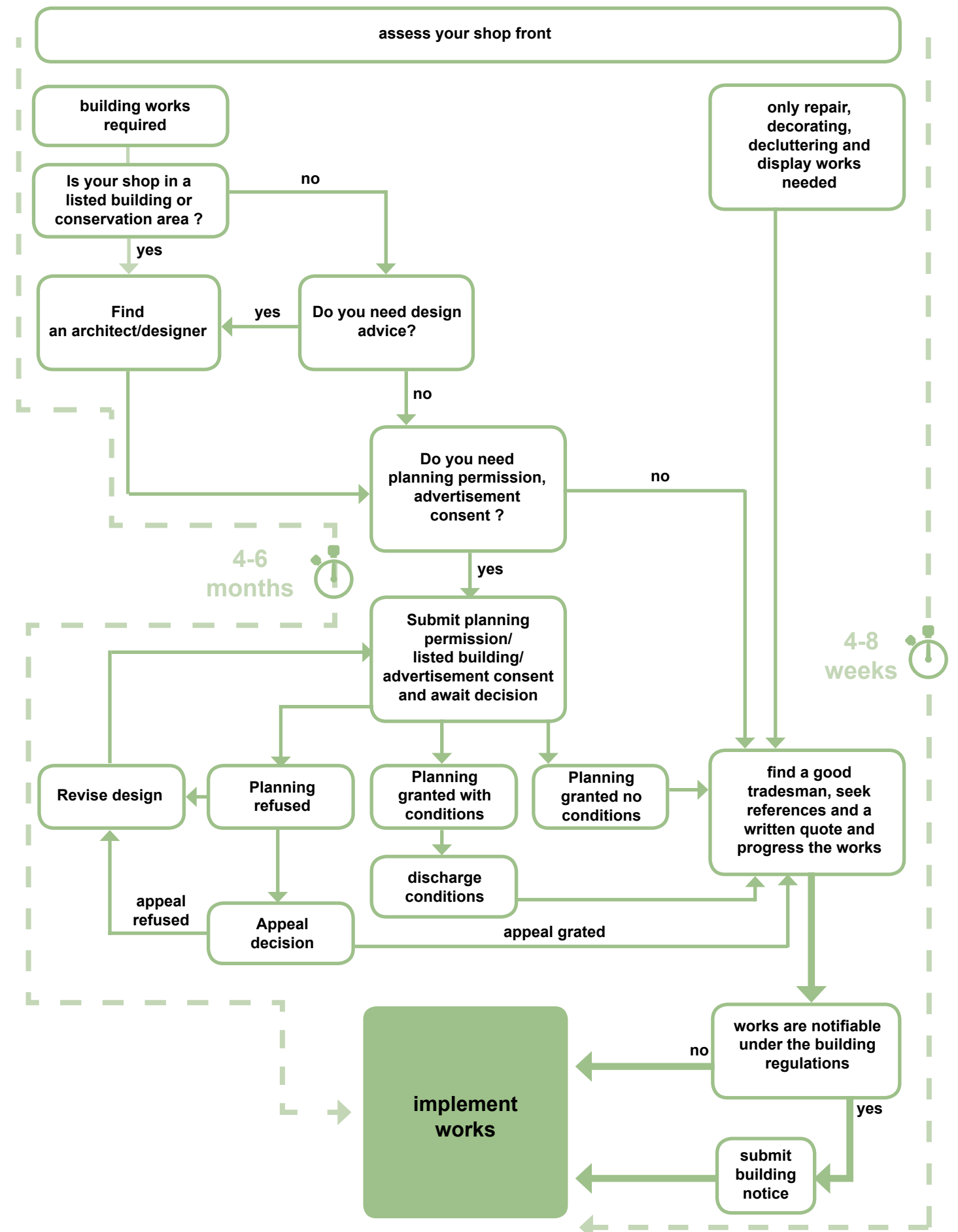

8.2 Design, Consent, Implement

Planning application tool

8.2.19 The following pages are designed to make the planning application process for shopfronts and signage easy. You need to have a recent version of Adobe Acrobat installed on your computer before getting started. Download Adobe Acrobat at <https://get.adobe.com/uk/reader/>

8.2.20 We have a number of building typologies along Merton's high streets in Mitcham Town Centre, Mitcham London Road, Wimbledon Town Centre, Colliers Wood, Morden & Raynes Park already drawn up.

8.2.21 From the following pages, download the drawing that matches your property by clicking on the link below the illustration and get started designing your new shopfront, ready to submit for planning approval.

8.2.22 If you cannot find a drawing that looks like your property, click download the 'blank template' and continue to follow the instructions.

8.2.23 Once downloaded follow the instructions on the Patternbook Template.

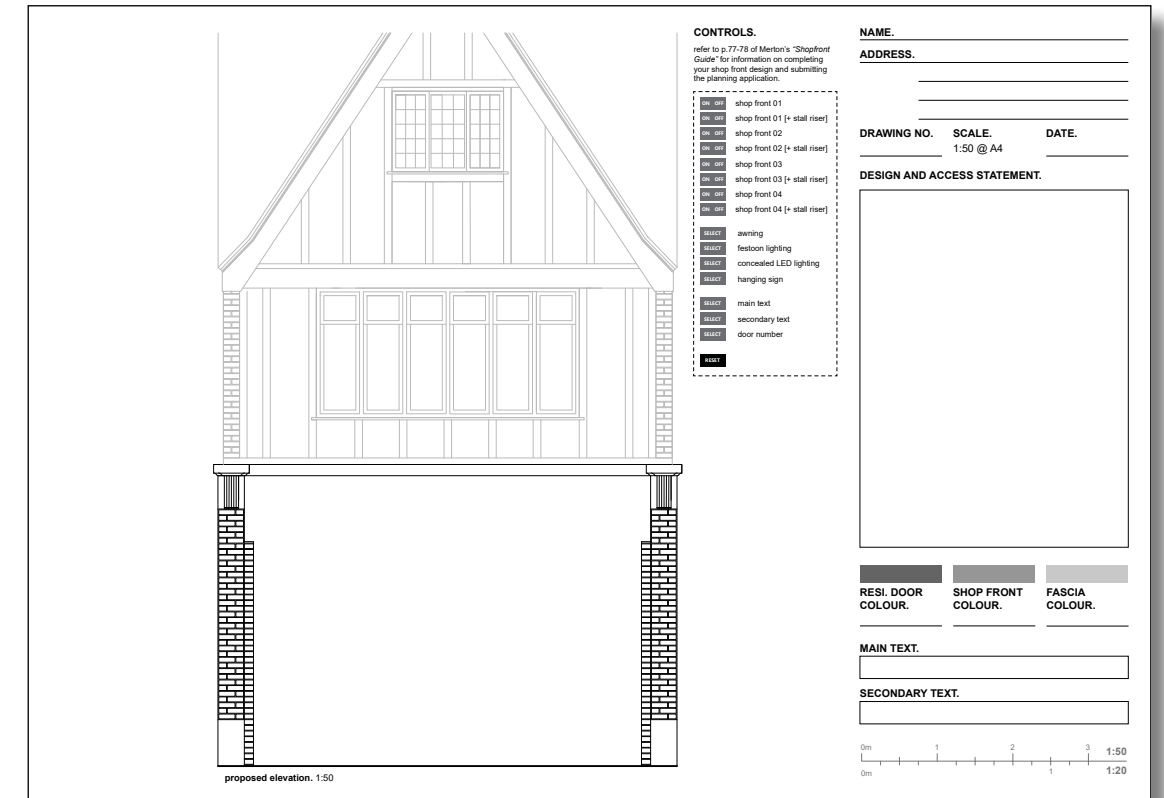

Morden: London Road [\[CLICK TO DOWNLOAD\]](#)

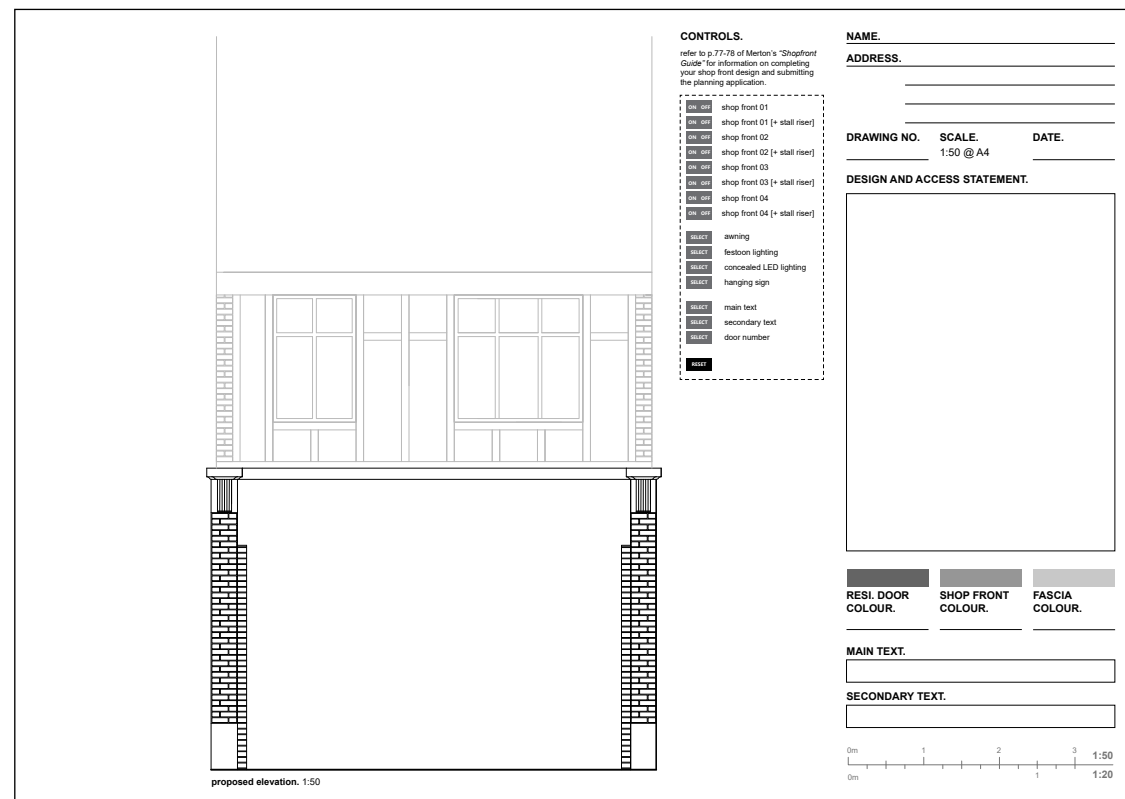

Morden: London Road [\[CLICK TO DOWNLOAD\]](#)

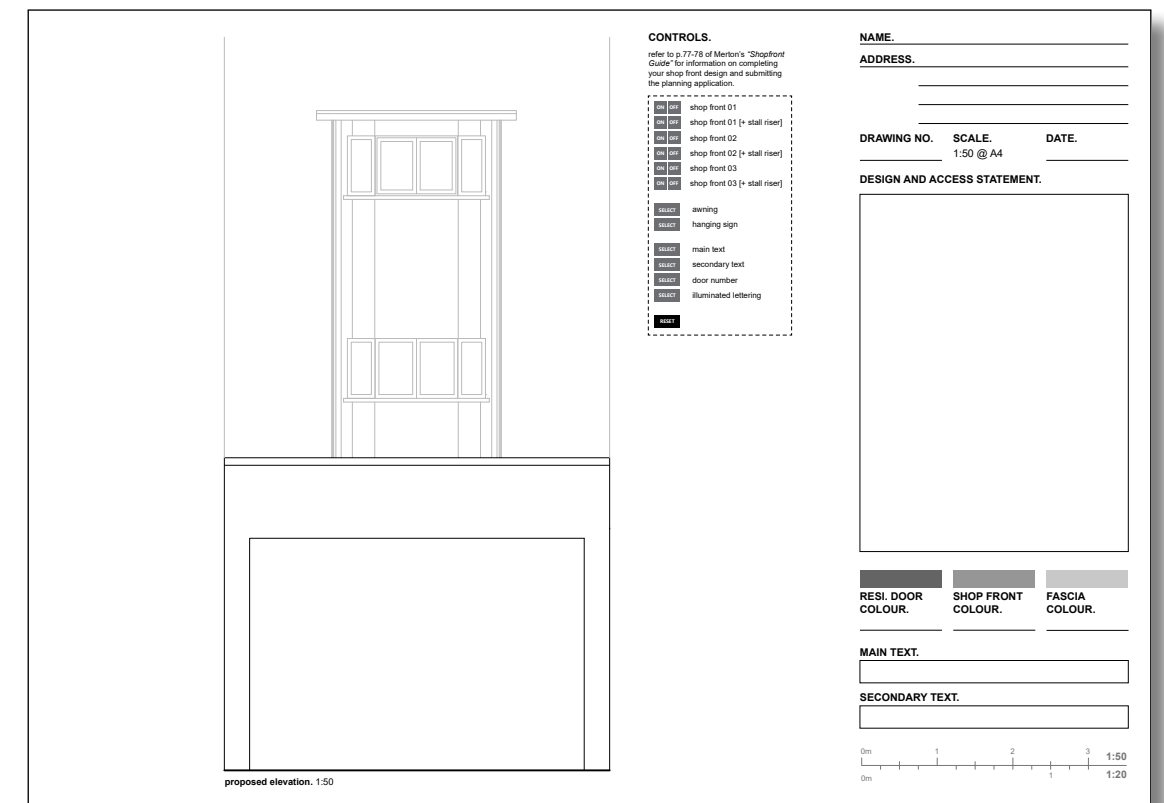

Morden Court Parade [\[CLICK TO DOWNLOAD\]](#)

CONTROLS.
refer to p.77-78 of Merton's 'Shopfront Guide' for information on completing your shop front design and submitting the planning application.

- shop front 01
- shop front 02 [+ stall riser]
- shop front 03 [+ stall riser]
- shop front 04 [+ stall riser]
- awning
- hanging sign
- main text
- secondary text
- door number
- illuminated lettering

NAME. _____
ADDRESS. _____

DRAWING NO. _____ **SCALE.** 1:50 @ A4 **DATE.** _____
DESIGN AND ACCESS STATEMENT.

RESI. DOOR COLOUR. _____ **SHOP FRONT COLOUR.** _____ **FASCIA COLOUR.** _____
MAIN TEXT. _____
SECONDARY TEXT. _____
0m 1 2 3 1:50
0m 1 2 3 1:20

proposed elevation. 1:50

Morden Court Parade [\[CLICK TO DOWNLOAD\]](#)

CONTROLS.
refer to p.77-78 of Merton's 'Shopfront Guide' for information on completing your shop front design and submitting the planning application.

- shop front 01
- shop front 02 [+ stall riser]
- shop front 03 [+ stall riser]
- shop front 04 [+ stall riser]
- awning
- festoon lighting
- concealed LED lighting
- hanging sign
- main text
- secondary text
- door number

NAME. _____
ADDRESS. _____

DRAWING NO. _____ **SCALE.** 1:50 @ A4 **DATE.** _____
DESIGN AND ACCESS STATEMENT.

RESI. DOOR COLOUR. _____ **SHOP FRONT COLOUR.** _____ **FASCIA COLOUR.** _____
MAIN TEXT. _____
SECONDARY TEXT. _____
0m 1 2 3 1:50
0m 1 2 3 1:20

proposed elevation. 1:50

Raynes Park [\[CLICK TO DOWNLOAD\]](#)

CONTROLS.
refer to p.77-78 of Merton's 'Shopfront Guide' for information on completing your shop front design and submitting the planning application.

- shop front 01
- shop front 02 [+ stall riser]
- shop front 03 [+ stall riser]
- shop front 04 [+ stall riser]
- shop front 05 [+ stall riser]
- awning
- festoon lighting
- concealed LED lighting
- hanging sign
- main text
- secondary text
- door number

NAME. _____
ADDRESS. _____

DRAWING NO. _____ **SCALE.** 1:50 @ A4 **DATE.** _____
DESIGN AND ACCESS STATEMENT.

RESI. DOOR COLOUR. _____ **SHOP FRONT COLOUR.** _____ **FASCIA COLOUR.** _____
MAIN TEXT. _____
SECONDARY TEXT. _____
0m 1 2 3 1:50
0m 1 2 3 1:20

proposed elevation. 1:50

Colliers Wood [\[CLICK TO DOWNLOAD\]](#)

CONTROLS.
refer to p.77-78 of Merton's 'Shopfront Guide' for information on completing your shop front design and submitting the planning application.

- shop front 01
- shop front 02 [+ stall riser]
- shop front 03 [+ stall riser]
- shop front 04 [+ stall riser]
- awning
- festoon lighting
- concealed LED lighting
- hanging sign
- main text
- secondary text
- door number

NAME. _____
ADDRESS. _____

DRAWING NO. _____ **SCALE.** 1:50 @ A4 **DATE.** _____
DESIGN AND ACCESS STATEMENT.

RESI. DOOR COLOUR. _____ **SHOP FRONT COLOUR.** _____ **FASCIA COLOUR.** _____
MAIN TEXT. _____
SECONDARY TEXT. _____
0m 1 2 3 1:50
0m 1 2 3 1:20

proposed elevation. 1:50

Mitcham: London Road [\[CLICK TO DOWNLOAD\]](#)

proposed elevation. 1:50

Mitcham: London Road [\[CLICK TO DOWNLOAD\]](#)

proposed elevation. 1:50

Mitcham [\[CLICK TO DOWNLOAD\]](#)

proposed elevation. 1:50

Mitcham: Fair Green [\[CLICK TO DOWNLOAD\]](#)

proposed elevation. 1:50

Mitcham [\[CLICK TO DOWNLOAD\]](#)

8.3. Merton's Town Centres

8.3.1 Merton's core planning strategy divides the borough into 5 sub-areas, Wimbledon, Colliers Wood, Mitcham, Morden and Raynes Park. The map below identifies the major centres, district centres, local centres and neighbourhood

parades across the borough. The content of this guide applies to all town centres, local centres, shopping parades as well as new-built retail space across Merton.

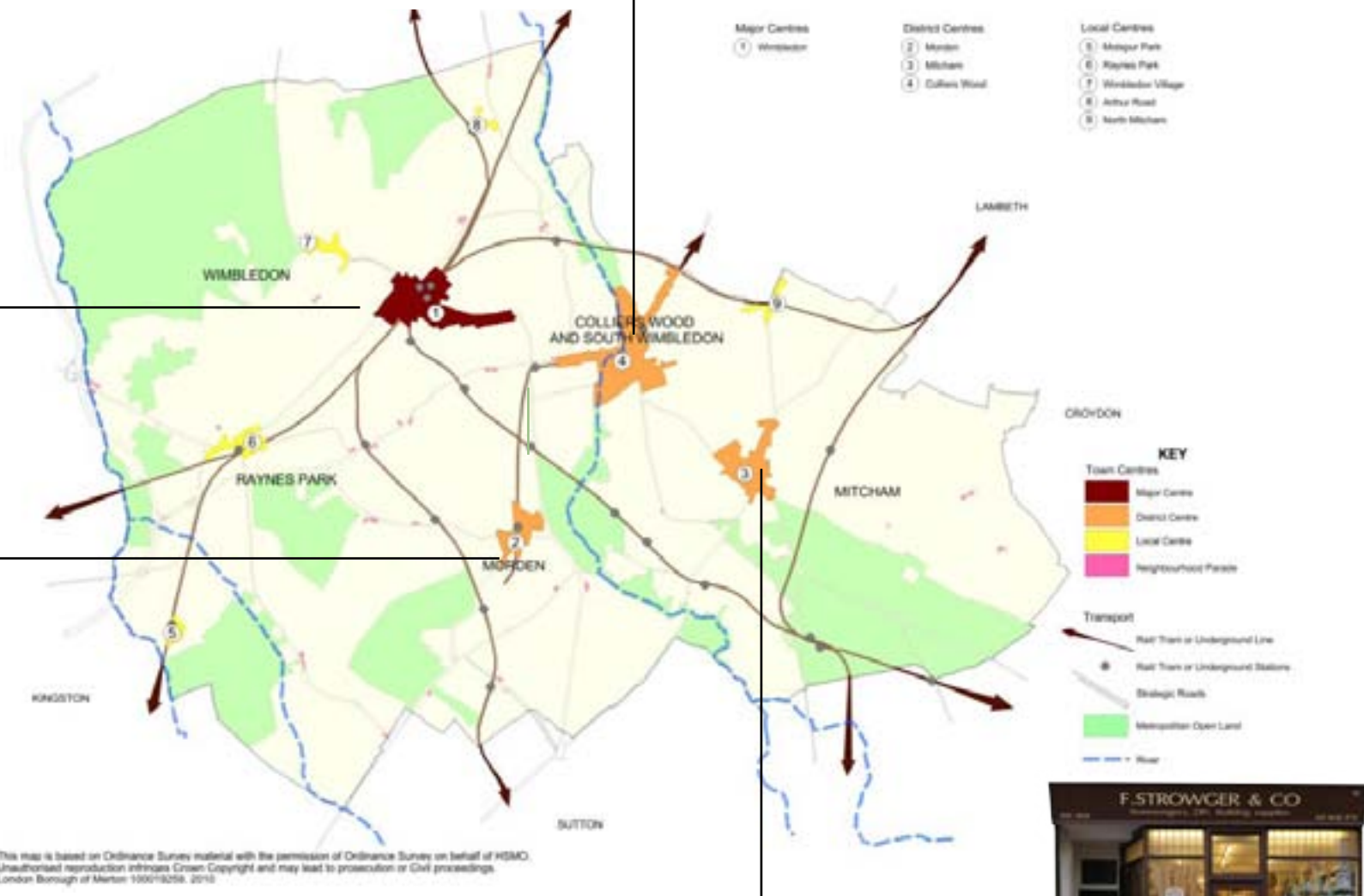

8.3. Merton's Town Centres

Wimbledon Town Centre

8.3.2 Wimbledon is one of London's major town centres with an internationally recognized brand identity. The centre has the strongest retail presence within the borough providing entertainment, shopping and services. Wimbledon's main retail area is concentrated along The Broadway and Wimbledon Hill Road, with further retail in the Centre Court Shopping Centre and around Wimbledon Plaza, east of the station and along St George's Road and Worple Road.

8.3.3 The townscape character is mixed. The eastern side of the station plaza is flanked by an elegant curving Art Deco parade with shops on the ground floor and stores or offices above. The Prince of Wales Pub, an impressive 4 storey Victorian Pub at the intersection between Wimbledon Bridge and Hartfield Road bookends a Victorian terrace with shops on the ground floor stepping down the incline of the Broadway towards Wimbledon Plaza. The post-modern facade of the shopping centre opens up to give way to a semi-circular crescent near the intersection with Queen's Road.

8.3.4 Further East along the Broadway, the density decreases with building heights dropping to three and later two storeys of mainly Victorian buildings with shops on the ground floor and residential above.

8.3.5 The character of the area between the Plaza and Palmerston Road is distinctly sub-urban, with low buildings and small retail units, before some larger scale office

and mixed use buildings start to dominate east of the Palmerston Road intersection.

8.3.6 The area along Wimbledon Bridge, immediately west of the station is characterized by recent development of between two and five storeys with predominantly larger retail units on the ground floor. Further west, after the Wimbledon Hill Worple Road intersection, the high street is defined by grand Victorian buildings with ornate brickwork in particular on Bank Buildings at nos. 37 to 47 Wimbledon Hill Road.

8.3.7 The diverse nature of architectural styles including Victorian, Art Deco, 1960s and turn of Century and the number of retail units derived from a change of use in Wimbledon town centre requires a bespoke approach to signage and shop front design, ensuring that any proposals complement the facade of the existing building.

8.3.8 Diversification of the retail sector is encouraged including strengthening the night-time economy, both grocery (convenience) and non-grocery (comparison) shopping and smaller, independent retailers.

8.3.9 The Broadway features a number of projecting shop units with parapets visible on the street elevation. Care should be taken that shop signs are correctly scaled, proportioned and aligned between the top of the parapet and the top of the shop front. Architectural features like Corbels

and corning can serve as a guide to determine the appropriate position and size of signs.

8.3.10 Disproportionately large signs or signs that extend beyond the width of the shop front are not acceptable.

8.3.11 Proportions of openings make the architecture of a building legible. New shop fronts should take up the full height of the retail unit. Existing suspended ceilings can be cut back to accommodate full-height shop fronts.

8.3.12 Many of the shops in Wimbledon have fine architectural features including curved glazing, tiled pilasters, corbels and corning. The Council supports the repair or reinstatement of features where they are damaged or lost.

8.2.11 Projecting signs should not be fixed to pilasters or corbels but should be suspended off a minimal metal bracket fixed to the main fascia sign.

Further reading:
The Broadway Wimbledon Conservation Area, Wimbledon Hill Road Conservation Area

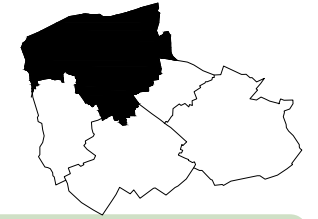

Wimbledon Wine Centre, 1 Gladstone Road



1. forecourt with seasonal planting
2. set-back entrance with tiled entrance lobby
3. visible interior and displays

8.3. Merton's Town Centres

Wimbledon Town Centre

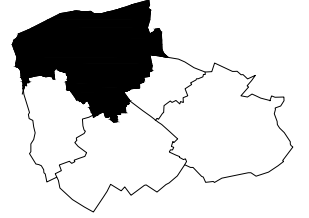

86 The Broadway Wimbledon



1. large open windows make the shop front inviting and approachable to passers by.
2. tidy outside seating creates a lively street scene.
3. consistent simple colour scheme with high contrast lettering.



8 The Broadway Wimbledon



1. large openable windows make the shop front inviting and allow for ventilation during the summer
2. tidy outside seating creates a lively street scene.
3. consistent simple colour scheme with high contrast lettering.
4. outside planter creates pleasant environment

8.3. Merton's Town Centres

Wimbledon Village

8.3.14 The High Street from the top of Wimbledon Hill Road to nearly as far as the war memorial, as well as the southern end of Church Road is defined by the Wimbledon Village Conservation Area. Retail units are predominantly located along High Street Wimbledon between the intersection with Wimbledon Hill Road in the east and High Street in the west and the southern end of Church Road. Retail units are generally small-scale and feature predominantly comparison retailers, cafes, restaurants and pubs.

8.3.15 A range of typologies combine to a charmingly eclectic collection of buildings. The northern side of the high street, near Lancaster Road features an elegant four storey Victorian terrace with shops on the ground floor and residential uppers. The facade is embellished with distinct linear stucco banding in the position of the

party walls. Directly adjacent to the west a single storey Art Deco terrace continues the retail parade until the intersection with Church Road, where it is book-ended by an impressive red brick Victorian bank building. The southern terrace on Wimbledon High Street is two and three stories high. Simple artisan buildings alternate with three storey Victorian buildings and some mid-century in-fill. Building heights on Church Road fall to two stories.

8.3.16 Many of the shop fronts in Wimbledon Village are original, with exquisite detailing including set-back entrances with mosaic floors, curved glass displays and coloured fanlights. The terrace at nos. 87 - 96 High Street retains fine granite-faced pilasters with ornate corbels featuring miniature relief faces on a floral stucco motif.



39B Senti Wimbledon
 ✓ 1. curved glazing makes the display visible from various angles
 2. set-back shop door creates dramatic entrance sequence
 3. feature lighting in display creates visual interest



14-2 Church Road Wimbledon

8.3. Merton's Town Centres

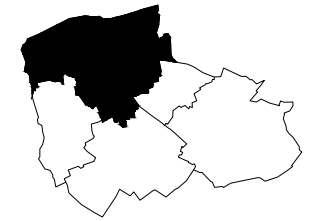

Wimbledon Village

8.3.17 The priority for Wimbledon Village in line with Merton's core development strategy is to maintain the uniqueness of the centre. The intimate scale of the street scene is a result of small-scale and diverse retail units.

8.3.18 The original shop fronts which have been preserved across Wimbledon Village are the result of regular and sympathetic maintenance and repair.

8.3.19 Where a new shop front is proposed, the arrangement of mullions and fanlights need to be carefully considered to complement the proportions of the original building, sometimes the details of a neighbouring building which retains an original shop front can provide guidance about arrangement, design and materiality.

8.3.20 Timber signs with painted or applied letters are appropriate in most cases and should be carefully integrated between the corbels and below existing cornices.

8.3.21 The pavements along Wimbledon High Street vary in width. In areas with wider pavement appropriately scaled timber A board signs can complement fascia signage.

8.3.22 Applications which seek to replace existing timber or steel shop fronts will need to demonstrate that the original shop front is beyond repair and that the replacement will be an enhancement.

8.3.23 The inter-connection of existing retail units to create larger shops is not appropriate in Wimbledon Village.

further reading: Merton Core Planning Strategy, Policy C 17, Wimbledon Village Conservation Area Design Guide



1-15 Merton High Street

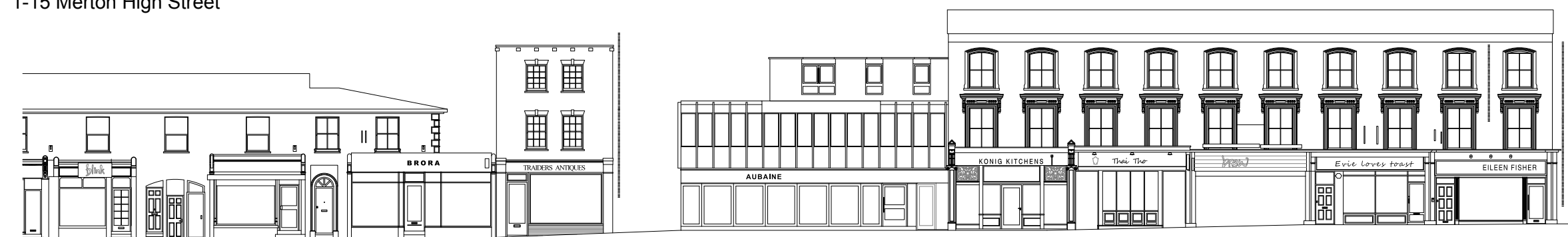

15-23 Merton High Street

8.3. Merton's Town Centres

Wimbledon Village

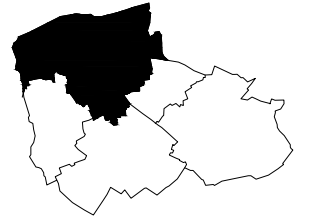

Castrads 38 Wimbledon High St

- 1. simple and effective colour scheme emphasizes the ornate detailing of the shop front
- 2. tiled entrance areas give the shop front depth
- 3. sign lettering integrates with fascia



Gail's Bakery 9 Wimbledon High St

- 1. forecourts occupied with tables, chairs and plants create a lively atmosphere on the street
- 2. simple stylish awnings contrast well with simple colour scheme
- 3. well-ordered display advertises merchandise

8.3. Merton's Town Centres

Arthur Road

8.3.24 Retail activity in the Arthur Road local centre is concentrated east of Wimbledon Park Underground Station and extends up until Dunsford Road. Arthur Road is a successful local centre which comprises a mixed and predominantly independent retail offer. A pharmacy, post office, bakery, several hairdressers, cafes and restaurants are complemented by specialist retail including a lighting shop, a bridal wear boutique and a vintner.

8.3.25 The architecture is of mixed character. 3 storey Victorian terraces with shops on the ground floor and residential uppers dominate near the station. Whilst a modern infill-development defines the character at the Dunsford Road end of the local centre. The contemporary development complements the character of the local centre where the ground floor features retail uses with open and active frontages. Buildings with closed, inward-facing ground floors are less successful.

8.3.26 On the north side of the road, striking red brick uppers with now painted ornate stucco banding are set back from the projecting shops at ground level. Most of the buildings retain their original timber windows.

8.3.27 The south side of the road features a Victorian building with (mostly) unpainted stucco banding and distinctive curved parapets.

8.1.28 Many shops have set-back entrances and original Victorian shop fronts with fanlights survive at nos. 128, 130, 146, 150

8.3.29 Green ornate tiling adorns the pilasters at nos. 126, 161 and 169 Arthur Road and has been painted over at a range of other properties along the high street. Many of the shops have historic tiling.

8.3.30 Any future development near the Dunsford Road intersection should feature active frontages with retail uses on the ground floor.

8.3.31 Proposals for new shop fronts seeking the removal of the characteristic set-back entrances, ornate tiling, pilasters or consoles will not be supported.

8.3.32 New signage should be designed to respect the proportions of the original design of the buildings and should not exceed the height defined by the lower section of the console. Fascia signs projecting forward of the console are not acceptable. Any projecting signs should be mounted to the fascia only.



Mr. Sparx at no. 130 Arthur Road and Park Vintners at no. 126 Arthur Road



1. open, uncluttered display
2. timber signboard respects proportions of existing building
3. set-back entrance
4. pilasters with original tiling

8.3. Merton's Town Centres

Colliers Wood

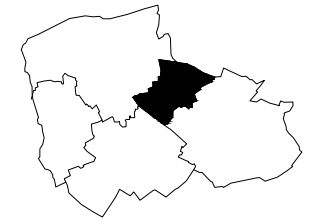

8.3.33 Colliers Wood town centre is spread out along High Street Colliers Wood between Priory Road and Valley Gardens and along the northern end of Christchurch Road in the form of the Priory, Tandem and Savacentre retail parks. The town centre lacks a clear focus with housing in between shops along High St Colliers Wood. To the west commercial uses merge into Merton High St. with a lack of distinction between the two High Streets, the Wandle being the boundary between the two.

8.3.34 The ongoing re-development of the Brown and Root Tower with active frontage at street level will enhance the legibility of the town centre. The station

parade along Christchurch Road features a plain two storey terrace with shops on the ground floor. Opposite the station, nos. 186 - 192 Colliers Wood High Street is a three storey C19 terrace.

8.3.35 Further north, between College Road and University Road a more substantial Victorian terrace with shops on the ground floor and two floors of residential above form a hard line of buildings along the northern edge of the street. This typology repeats, interspersed by lower or set-back development. The southern side of the high street has more by low rise residential development alternating with terraces of shops and residential above.

8.3.36 Many building facades along Colliers Wood High Street are in a poor state of repair. To maximise visual uplift, any works to shop fronts and signs should be complemented by works to uppers including re-pointing of brickwork, stucco repairs and decorating and the removal of clutter including satellite dishes, alarm boxes and redundant signage. Satellite dishes should preferably be located at the rear of the building or on the roof, where they are not visible from the street.

8.3.37 Where the upper parts of buildings are rendered or painted, a well composed, complementary colour palette can help to brighten and animate the street scene.

8.3.38 Businesses on High Street Colliers Wood have a poor night time presence. Well-considered signage and display lighting in combination with internal, set-back roller shutters can improve an area's appearance and advertise a business even when it is closed and at night.

Further reading: Merton Core Planning Strategy Policy CS 1, Colliers Wood Sub-Area Neighbourhood Character Guidance



108-88 High Street Colliers Wood

8.3. Merton's Town Centres

Colliers Wood

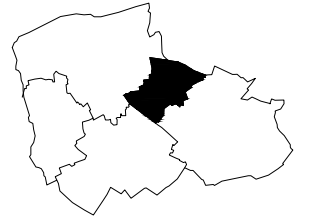

High Street Colliers Wood

1. uppers cluttered with signs and satellite dishes
2. stucco features dilapidated
3. leaking rainwater goods causing damage to building envelope
4. shop signs misaligned and obscuring architectural features
5. roof fascias dilapidated
6. pilasters cluttered with signs and services
7. projecting shutter boxes obscure shop signs
8. closed shutters/blinds give a hostile appearance
9. poorly conceived colour scheme detracts from building features
10. empty display gives a neglected appearance



The parade still retains many original features which could be improved through shop front enhancement

8.3. Merton's Town Centres

Mitcham Town Centre

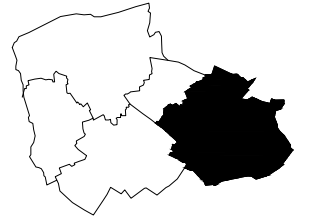

8.3.39 The heart of Mitcham Town Centre is defined by Mitcham Fair Green. The Green itself and the arrangement of buildings around it reinforce the town centre's 'village' origins.

8.3.40 Retail parades are mostly concentrated around the Green and along London Road and Upper Green East, with larger retail uses and supermarkets in the St Mark's Road and Majestic Way triangle and along Western Road.

8.3.41 The town centre's architecture is diverse. The 19th Century terraces on Upper Green East and London Road with shops along the ground floors and residential above are complemented by tudor revival buildings at the western end of Fair Green as well as a 1920s terrace on the Eastern side of London Road and examples of 1950's, 60's building around the edge of the Green. (see also Mitcham Sub Area Neighbourhoods).

8.3.42 The Upper Green West terrace defines the northern edge of the Green. Nos. 9 & 10 with their distinct tiled gables book-end the terrace in the west. Nos. 8, 7 and 6 constitute a group of Tudor revival buildings with elegant narrow elevations and half-timbered uppers. Nos. 5, 4, 3 and 2 form a group of 4 simple 2-storey 19th Century buildings and the Eastern end of the terrace is book-ended by recent mixed-use development. The Upper Green East is just as diverse, featuring 19th Century, 1930s and 1950s development all in the same terrace.

8.3.43 Wide-ranging improvements to Mitcham Town Centre as part of the Rediscover Mitcham town centre regeneration project, are well advanced in line with the Council's policy CS 2 including public realm and shop front enhancements. This is complemented by new housing and improvement to leisure and community infra-structure.

8.3.44 Mitcham's retail landscape is as diverse as its architectural heritage. Pound shops feature alongside banks, restaurants, supermarkets, specialist retailers, and cafes. A reinvigorated market occupies part of Fair Green. The wide pavements along Upper Green East allow retail displays and restaurant seating to occupy and animate the pavements.

8.3.45 159 - 185 London Road and Monarch Parade opposite define a small neighbourhood centre on the northern fringe of Mitcham. The two buildings of Monarch Parade face London Road on the west side, and are featureless flush rendered blocks with shops on the ground floor and three residential upper floors. Pavements are wide and there is potential for outside seating and displays. 159 - 185 London Road comprises two ornate Art Deco terraces between St Marks' Road and Armfield Crescent. There are shops on the ground floor and residential on the first floor. Mitcham Public Library a well-proportioned Neo Georgian building dating from 1933 - marks the northern end of the terrace. The retail offer is targeted at the local neighbourhood.



F. Strowger & Co. at no. 14 Upper Green East retains its original timber shop front with typical transom lights. The use of forecourts to display merchandise contributes to the liveliness of the town centre.

1. carefully conceived signage gives just the right amount of information - no more, no less
2. set-back residential entrance door gives precedent to the shop front
3. translucent glazing in fanlights refracts shop lighting making shop appear bright, even on an overcast day

8.3. Merton's Town Centres

Mitcham Town Centre

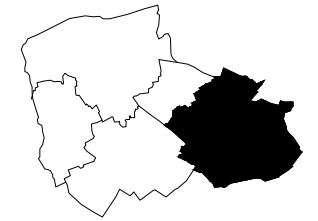

8.3.46 The distinctive character of 159 - 185 London Road and its architectural detailing significantly contributes to the identity of the area. Most of the existing shop signs cover up important features like cornicing and pilasters.

8.3.47 Illuminated box signs are incongruous with the existing building and should not be used. Any new signs at nos. 159 - 185 London Road should not cover up the features and detailing of the existing building. In particular, they should integrate with the distinct stepped cornicing and align with the sides of the pilasters. Illuminated box signs are inappropriate, instead, flush timber

or aluminium signs should be used. Where illumination is required, individual illuminated letters or festoon lights would be appropriate.

8.3.48 Merton Council recognises the distinct cultural identity of the area and seeks to support businesses, retail outlets and institutions that contribute to this.

8.3.49 With the wide diversity of styles in close proximity, it is particularly important that vertical divisions between buildings and groups of buildings remain distinct. Signage and shop fronts which extend across 2 or more units - in particular where the units do not form part of the same

group of buildings, disrupt the contiguity of architectural styles in the terrace.

8.3.50 Any new shop fronts in Mitcham need to respond positively to the design of the host building, recognising its particular architectural features and horizontal and vertical proportions.

8.3.51 New shop fronts and new signs should be designed to help reinforce the consonance of a group of buildings. In particular the horizontal alignment of stall risers, signs and fanlights can help to reinforce the coherence of a group of buildings.

8.3.52 Materials for new shop fronts should be appropriate to the host building. Whilst a timber shop front and signage is generally appropriate for pre-war buildings, minimal metal shop fronts or frameless shop front systems are often appropriate for post war buildings.

Further reading: Merton Core Planning Strategy, Policy CS 2, Mitcham Local Neighbourhood Character Areas Assessment. Mitcham Sub-Area Neighbourhood Character Guidance



London Road Mitcham

FAIR GREEN PARADE



Fair Green Parade Mitcham

8.3. Merton's Town Centres

North Mitcham

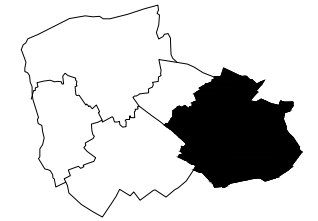

8.3.53 The main retail centre stretches along Mitcham Road from Southcroft Road in Lambeth in the north across the borough boundary up until the corner of Figgs Marsh in Merton in the south.

8.3.54 North Mitcham features building stock from a range of eras. Victorian buildings of mixed quality combine with mock-tudor and low quality retail buildings at the Inglemere Road junction, adjacent to Tooting train station and opposite the Glasford Street junction. A low rise Art Deco retail parade adjacent to the impressive Tooting Police Station marks the gateway into Merton from the north.

8.3.55 Building heights vary from single storey adjacent to the railway bridge to 3 storey terraces with roof extensions immediately south of the station dropping to two storeys near Figgs Marsh. North of the railway line building heights are mainly one and two storeys.

8.3.56 The terrace at nos. 16 to 28 London Road features exquisite relief gable decoration at nos. 16, 20, 22, 24 and 28.

8.3.57 Several vacant units and a building ruin adjacent to no. 28 London Road indicate that North Mitcham's retail sector is struggling. Buildings are almost exclusively in a poor or very poor state of repair. Shop fronts are predominantly dilapidated, and signs incongruous with host buildings. Many uppers are rendered with pebbledash render. Rainwater goods clutter the front elevations. External shutters give the high street a hostile appearance when shops are closed. The public realm has a tired appearance.

8.3.58 Shops at nos. 279 - 313 Mitcham Road have deep forecourts some of which have been converted to car parking.

8.3.59 A simple contemporary shop front with an internal roller shutter is preferable where a new shop front is proposed.

8.3.60 Where a stall riser is proposed, this should be build out of masonry or timber to account for the sloping pavement.

8.3.61 The use of forecourts for car parking has a detrimental impact on the shopping parade. The Council will not support applications for new car parking on forecourts and welcomes applications that seek to remove car parking from retail forecourts.

8.3.62 Whilst the Council supports the use of private forecourts for retail or restaurant seating, permanent or semi-permanent extensions on forecourts are not supported.

8.3.63 The design for any new shop front should seek to integrate shop entrances and entrances to the residential uppers, ideally with doors arranged symmetrically adjacent to each party wall.

8.3.64 Proposals for new shop fronts and signage should include the repair and decorating of pilasters, corbels and cornices.

8.3.65 Where building uppers are rendered or previously painted, re-painting in a well-considered colour is encouraged, stucco elements including pilasters, corbels and cornices should however be painted white.



- 1. uppers stained and rendered with pebbledash
- 2. signs clutter facade
- 3. unsympathetic rainwater goods clutter facade
- 4. poorly conceived colour scheme detracts from building features

- 5. closed shutters/blinds give a hostile appearance
- 6. UPVC shop front incongruous with building
- 7. pilasters painted in 2 colours
- 8. shop front cluttered with signs/stickers



London Road, North Mitcham

8.3. Merton's Town Centres

Morden

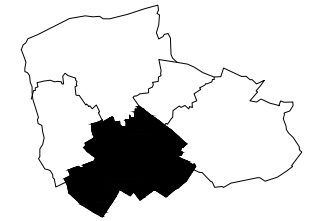

8.3.66 Morden Town Centre is an important district centre with good transport links to Central London. The main retail core is clustered around the Underground station, along London Road between Morden Court in the South and the Morden Hall Road in the north-east. Secondary retail parades line Abbotsbury Road and Crown Lane. Larger supermarkets are integrated into the street pattern, along the fringes of the retail centre. Morden's building stock is more recent compared to other town centres in Merton. Low-rise, 1920s terraces with shops on the ground floor and residential uppers dominate. Some 20th-century buildings, including the civic centre and the station building are also present. A mock tudor parade and the white rendered Art-Deco Morden Court Parade mark the southern entrance into the town centre.

8.3.67 Merton's Core Planning Strategy has identified Morden Town Centre as a key regeneration area with new housing, new retail, office accommodation and leisure facilities. Guidance for the design of new retail frontages is given in section 8.2.

8.3.68 New buildings facing the high street should engage with the pavements, providing open and welcoming frontages. Consideration should be given to the design of entrances, signs, canopies, awnings and surrounds to create visual interest by giving new shop fronts depth and three dimensionality.

8.3.69 Where new shop fronts and signage are proposed for existing retail units, these should be designed to integrate with existing building features, including pilasters, corbels and corning. On facades without decorative features, new signs must not exceed the width of the shop front.

8.3.70 At Morden Court Parade, simple painted signage or applied lettering to the 1st floor parapet is preferred. Where additional signage is needed, individual vinyl letters can be applied to shop front glazing. Any new signage or shop front should not conceal the reveals of the structural opening of the shop front.

Further reading:
Morden Sub area neighbourhood character study



Ellisons 24 Crown Lane, Morden Town Centre



1. timber shop front can be re-branded, customised and repaired
2. proportions, stall riser and door respond to existing building
3. shop display is open and allows for view into the interior



Morden Court Parade, Morden Town Centre

8.3. Merton's Town Centres

Raynes Park

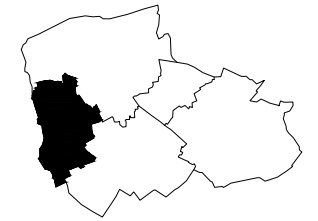

8.3.71 Raynes Park is a suburban neighbourhood west of Wimbledon with a wide variety of architectural styles and typologies including Victorian, art deco and contemporary buildings. Building heights vary from 6 to 2 stories, although overall, buildings have small foot prints and are only 2-3 stories high.

8.3.72 The properties overall are maintained to a high standard and a number are located in one of the three local conservation areas.

8.3.73 Raynes Park is bisected by the railway line which creates a barrier and has led to the development of a primary and a secondary shopping core to service opposite sides of the tracks and train station.

8.3.74 The primary core is located along Coombe Lane, clustered around the station entrance but also includes shops on Lambton Road, Worple Road & spradic shops on Durham Road. As well as Kingston Road and Approach Road on the south side fragmented and dispersed with residential. The Coombe Lane terrace is composed of a 2 storeys Edwardian terraces with strong horizontal features. A 3 storey C19 bank building with circular granite columns and a Victorian pub with turret are dominant buildings in the area.

8.3.75 East along Coombe Lane, near the Wyke Road intersection, A2 uses take over from retail until the area turns residential beyond the Worple Road intersection.

8.3.76 Towards the west, retail activity slowly dissipates with Ave Road marking the transition into residential. The secondary retail parade - although with a more basic retail offer - add to the diversity of the offer in Raynes Park.

8.3.77 The parade on Approach Road, an early C20 block with imposing mansard roof opposite the station entrance marks the southern edge of the local centre.

8.3.78 The town centre is characterised by a lively pavement culture with cafes and restaurants with outside seating and shop displays at the back of the pavement. Supermarkets and retail chains are well integrated into the general street pattern.

8.3.79 The retail along Coombe Lane is a well-used local asset and any new development should feature retail

premises on the ground floor, including smaller units. Towards the edges of the town centre, mixed-use development can provide A2 and D1 space at ground floor level.

8.3.80 Where shops occupy more than one retail unit in a parade, their signage and shop fronts should respect the vertical division between individual buildings and retain pilasters and corbels. Signs should be designed to accommodate this division.

8.3.81 Any projecting signs should be proportionate to the scale and height of the host building to ensure that they don't appear out of scale.

Further reading: Raynes Park Sub Area Neighbourhood Study. Lambton Road Conservation Area appraisal.



66-44 Coombe Lane, Raynes Park

8.3. Merton's Town Centres

Motspur Park

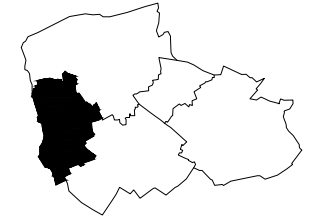

8.3.82 Motspur Park local centre comprises 3 parades of shops along West Barnes Lane, clustered around the Earl Beatty Pub.

8.3.83 The architecture along the high street is uniform, featuring 2 and 3 storey early C20 buildings with half-timbered gables at regular intervals and distinctive red herringbone brickwork at 1st floor level on two of the parades. The character of the area is distinctly sub-urban with abundant car parking, wide roads and deep pavements. Original timber shop fronts with fanlights, stall riser and set-back doors to shops and residential uppers are retained at nos. 326, 328, 332, 336, 341 and 346. The proportions of the buildings and original shop fronts are horizontal, with generous glazing at eye level. Signs are characteristically narrow.

8.3.84 A number of retail units in Motspur Park are vacant and several of the shops are occupied by A2 uses with partly obscured glazing.

8.3.85 The retail diversity in Motspur Park is dominated by hot food take aways, restaurants, cafes and hairdressers.

8.3.86 The arrangement of mullions, transoms and stall risers for any new shop fronts in Motspur Park should reflect the proportionality of the existing building.

8.3.87 New signs should occupy the narrow space between the exposed bressummer and the top of the shop front. Additional text/information can be applied to shop front glazing with cut-out vinyl lettering.

8.3.88 The Council welcomes proposals for interim, community or creative uses of shops that are currently vacant as long as uses engage with the street and retain an open aspect onto the pavement.

8.3.89 The use of the wide southern pavement on West Barnes Lane for outside seating is welcome where a valid pavement licence is in place.

8.3.90 The Council welcomes proposals that would diversify the retail offer in Motspur Park, in particular proposals for convenience retail or specialist retail will be supported.



359 - 365 West Barnes Lane

8.4. Maintenance

Cleaning

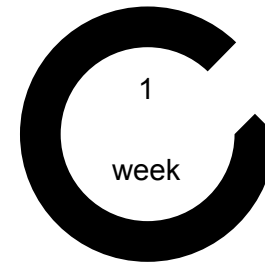

8.4.1 Air borne pollutants and organic matter from plants and trees are common in any urban setting. Many pollutants contribute towards the premature deterioration of building materials including fabrics, paints and metals. Settling organic matter creates a fertile ground for the growth of fungi and bacteria which created the need for more regular repair/replacement/ decoration then is necessary.

8.4.2 Timber shop front, paintwork, signs & security shutter: clean with warm water and washing up liquid, using a soft cloth or sponge. Avoid in all instances the use of harsh or abrasive chemicals. Keeping the shop front clean avoids the build-up of soot (from car exhausts) which is acidic and attacks paint surfaces and traps moisture. A clean shop front won't need to be painted as often as a dirty one.

8.4.3 Windows: There are specialist glass cleaning products, however cleaning with warm water and washing up liquid is great. Glass is best cleaned with a soft broom/brush and a professional rubber squeegee with a long handle. You may also consider employing a window cleaner to ensure regular maintenance.

8.4.4 Awnings: awnings should be brushed-off with a soft brush regularly to avoid dirt building up. When the fabric needs washing, use a hosepipe or bucket and a mild soap. Rinse off immediately and allow to dry before winding the blind back up into its housing. Do not use detergents or harsh chemicals as this may fade the colour and remove waterproof.

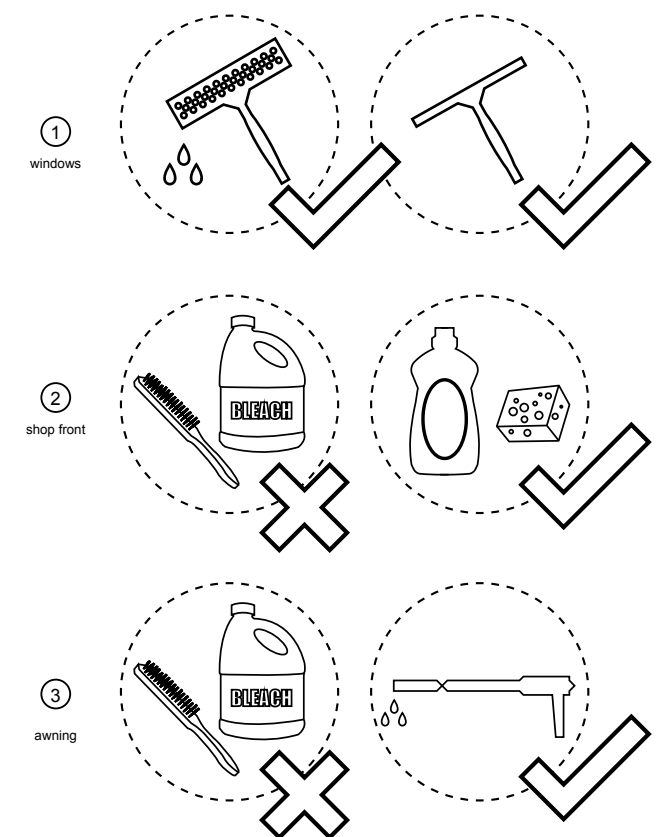
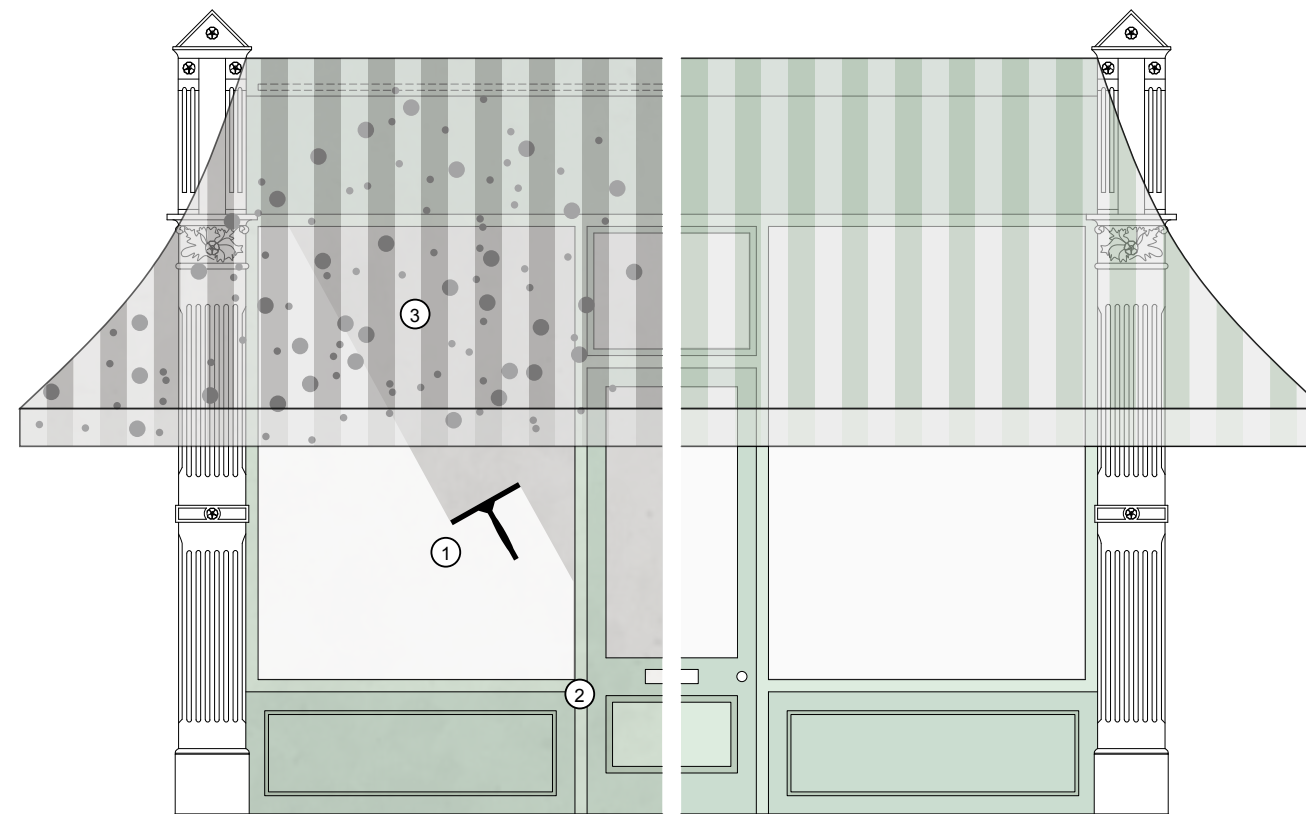

8.4. Maintenance

Timber repair & decorating

8.4.5 Check regularly for: (1) Areas where the paintwork has worn away or flaked, exposing the timber below especially sills. (2) Areas where the paintwork has been scratched or damaged which could be allowing water to penetrate.

8.4.6 Repainting timber: (1) Rub down paint using a fine grade sand paper taking care to remove areas of flaking. (2) In areas where flaking has occurred, apply one coat of Primer. (3) If the timber is damaged, apply a two pack wood filler and rub smooth. (4) Once dry apply one coat of Paint in the designated colour following the manufacturer's recommendations. Make sure all surfaces are perfectly clean before painting. The paint on a dirty surface will only last a few months before it starts peeling off again. Good quality tools will ensure the paint is applied evenly and will make it last longer.

8.4.7 Repainting in a new colour: To repaint in a different colour, rub down and apply one coat of undercoat paint followed by 2 coats of paint in the chosen colour. Using professional quality external paint will prolong maintenance cycles.

Refer to links below for further instruction.
 Sikkens Wood Coatings: <http://www.sikkens-wood-coatings.co.uk/en/service/download-area/general-information.html>
 Farrow and Ball: <http://www.farrow-ball.com/preparing-exterior-woodwork/content/fcp-content>
 Dulux Weathersheild: <https://www.dulux.co.uk/en/products/exterior>

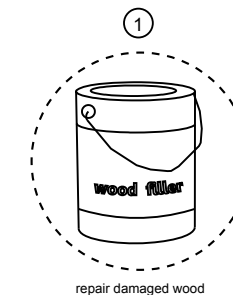
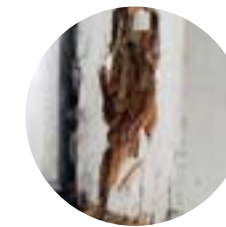
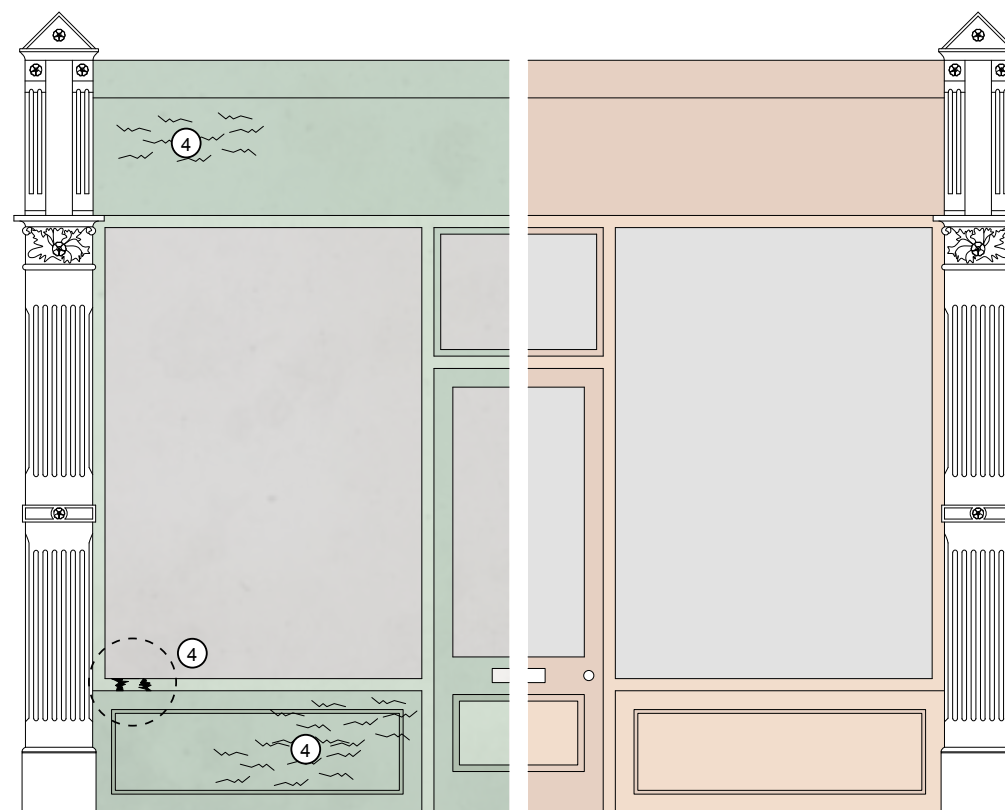
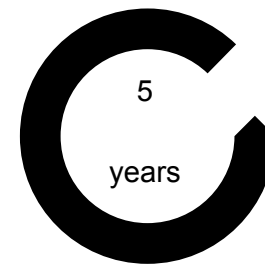

repair damaged wood

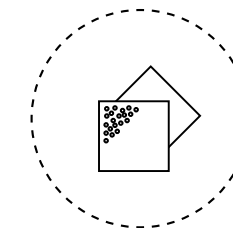

sand paper

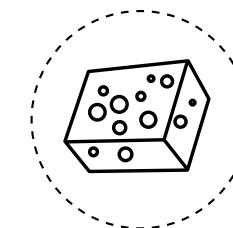

wipe clean

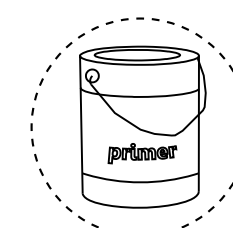

apply primer

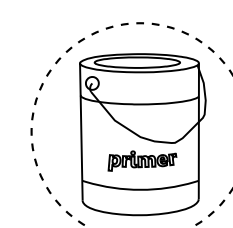

apply paint

8.4. Maintenance

Timber repair & Decorating

8.4.8 Repainting Pilasters (1) Remove all loose, flaking and unstable material. (2) Wash down surfaces with clean cold water so that the surface is free from dust and surface contaminants. (3) The Keim Restauro System can be used to repair damage to sills, stucco features and render surfaces. (4) Apply 1st undiluted coat of Keim Soldalit using a brush or roller. (5) Allow to dry for 12 hours and apply second undiluted coat.

Refer to links below for further instruction.
 Keim: http://www.keimpaints.co.uk/products/natural_stone_repair/restauro_system/our_restauro_system/
 Farrow and Ball: <http://www.farrow-ball.com/preparing-exterior-masonry/content/fcp-content>
 Dulux Weathersheild: <https://www.dulux.co.uk/en/products/exterior#sur=Masonry>

5
years

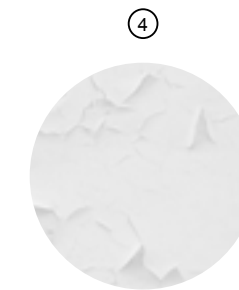
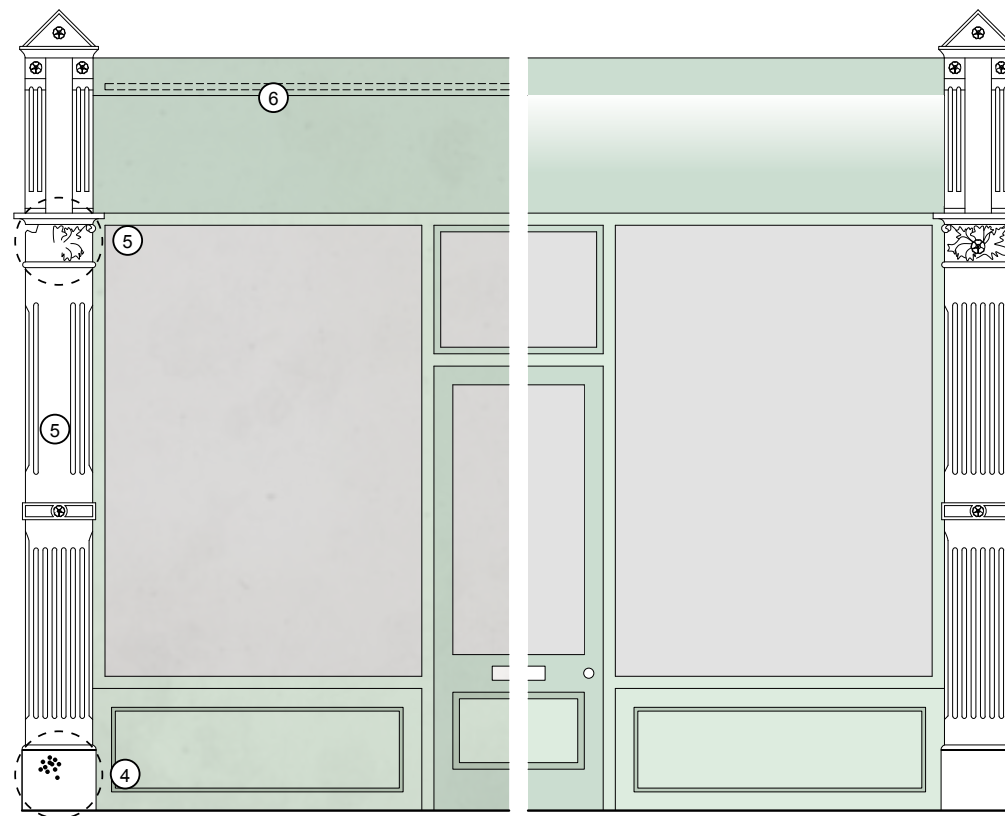

flaking paint

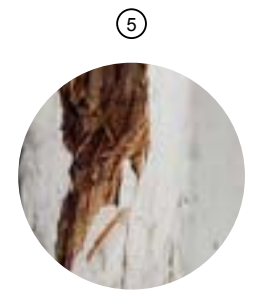

damaged render/ stucco

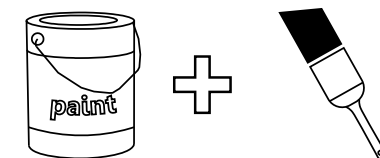
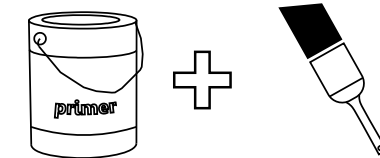
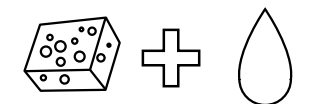
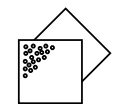
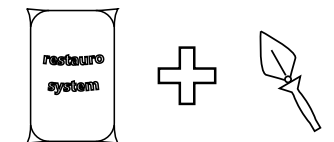
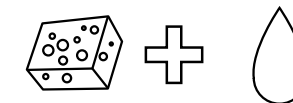
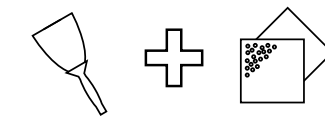

8.5. Conversions to residential use

The need for guidance

8.5.1 When shops become unviable or go out of business, there is often a desire to convert them to residential use – sometimes the original use of the building. This often happens in more peripheral areas and where they are outside designated shopping areas.

8.5.2 These are often on busy roads in highly visible locations. Where there is no private frontage, the environment is hostile for a residential use and attempts at managing this can create designs that minimise interaction with the street and present an unattractive and dead frontage to a street.

8.5.3 This is also usually not very sympathetic to the character of the remainder of the building above the shop-front. The council recommends that in most cases, key elements of the original shopfront are retained, as they are an historical remnant, part of the character of the street and often fit well with the remainder of the building. It is also more visually appropriate if the building is in an area where a number of other retail uses and shop-fronts remain.

8.5.4 In some cases, usually in more peripheral areas, it could be more appropriate to fully restore the residential frontage and remove all traces of the shop-front. In this instance, each case would need to be considered on its merits.

Policy context

8.5.5 Policies relevant to the conversion of shops to residential use are to be found in the council's Sites and Policies Plan. These are as follows:

- DM R3 Protecting corner/local shops
- DM R4 Protection of shopping facilities within designated shopping frontages
- DM D2 Design considerations in all developments
- DM D3 Alterations and extensions to existing buildings
- DM D4 Managing heritage assets

These policies must be taken into account and adhered to when making proposals for converting shop-fronts to residential use

Planning permission

8.5.6 In most cases, change of use from a retail use class (A class) to a residential use class (C class) will require planning permission. Irrespective of the change of use, any material physical change to the appearance of the shop-front is likely to constitute development that requires planning permission.

There are some exceptions:

- Change of Use from office (Use Class B1(a)) to a dwellinghouse (Use Class C3) is permitted subject to the Prior Approval process (as opposed to requiring Planning Permission). This process gives permission in principle, subject to the local planning authority being satisfied there are no adverse impacts relating to traffic and highways, contamination and flood risk.
- Change of Use from A1 and A2 retail use to residential can also be implemented through the Prior Approval process as outlined above, subject to the cumulative floorspace of the building being under 150m².

8.5. Conversions to residential use

Design guidance

8.5.7 Changes to the shop-front should respect and retain where possible the key elements of the original shop-front and the new frontage fit harmoniously with the remainder of the building frontage. The scale, architecture and style of the host building should inform the design of the new frontage replacing the operational shop-front. Design guidance, in the form of do's, don'ts and other examples are given in the following detailed guidance.

8.5.8 In cases where a property was originally a dwellinghouse, but later converted to a shop, it may be more appropriate to restore the whole frontage

back to its original residential appearance. Many cases exist where the original house had a small front garden, which has subsequently been paved over and forms part of a continuous footway in front of several neighbouring shops or former shops. In such cases, restoration of the front garden would be considered as a necessary part of the new design, as residential frontage directly onto footways, particularly on busy streets, offer a poor sense of privacy and defensible space. This is less of an issue where the street is less busy or the original building did not have a garden, and fronted directly onto the footway.

8.5.9 Heritage assets, whether they are in conservation areas, listed or locally listed building, or any other identified asset, should be treated with particular care and consideration. This should include an identification of what is of particular interest, consideration of removal of unsympathetic features and retention and renewal of historic features where appropriate. There is a presumption in favour of retention of the original shop-front with all heritage assets. Reference should be made to the relevant list descriptions and character appraisals to inform design.

8.5.10 Buildings can be listed or nominated in the 'community right to bid', where the local community can identify a building for sale as having a potential community use. This removes all permitted development rights – such as change of use, alterations to the shop-front and prior approval rights – for a period of 6 months to allow the community to enter a successful bid for its purchase. If, after six months, the bid is unsuccessful, normal permitted development rights and planning policies apply.

Poor examples of shop conversions



Architecture: Original pilasters, fascias, stall-risers and related detailing should be retained and all unoriginal features removed. This should form the 'canvas' for the new residential frontage. In some cases, where there are significant window frames, these can be successfully incorporated into a new residential frontage.

Materials: Materials and finishes should also be informed by the character of the host building.

Windows and Doors: If the original shop-front window is to be replaced, the new window must fit harmoniously with the building façade and original windows above, particularly with respect to size, position, proportion, style and materials.

Access: Many shop-fronts include an adjacent door to the street giving access to flats above. These are an original feature of shop-fronts and should be retained where possible. It is preferable for the new ground floor unit to be accessed via this door also. Where this is not the case, then any new door must be well designed and integrated into the ground floor façade and match the other door present in design and style. In many cases original doors are recessed into the façade and this is a detail that should be retained.

8.5. Conversions to residential use

Good example of shop conversion

Architecture: Pilasters, corbels etc. and fascias should generally be retained and unsympathetic additions removed. Fascias should be re-coordinated with adjacent units if appropriate.

Style: Conversions should complement the building as a whole and retain or enhance its character. The design of windows, doors and detailing should be based on the original details of the host building. Elements of the shop-front will often contribute to the character of the building frontage and these should normally be retained and, if needed, restored.

Materials: The correct choice of materials is particularly important to ensure a successful conversion. Care should be taken to ensure materials used match those of the host building, particularly with respect to matching bricks, mortar colour pointing style and coursing-in with existing brickwork. Weather struck pointing should generally be avoided

Windows & Doors: Appropriate choice of windows and doors is critical to a successful conversion. Their style should be appropriate to the age and character of the host building.

Alignment: In general, the alignment of new windows should have a clear, logical and harmonious relationship to those on upper floors. Normally, ground floors have higher ceilings than upper floors and this larger proportion should be reflected in the scale of the new windows at ground floor. New ground floor windows should be as large as, or slightly larger than, those on the floor above.



Access: If there is already an independent access to upper floor flats, then ideally this should be utilised as the access for the new ground floor unit, with a small internal communal lobby. Where this is not possible, care is needed in positioning the new door. It should relate harmoniously with the arrangement of the other door and window on the ground floor, and the windows on the floors above.

Design guidance

8.5.11 Proposals for the partial conversion of a shop should not compromise the remaining space as a viability shop unit. This could include the removal of rear or upper storage areas such that the remaining space could not properly function as a shop.

Example 1 Shop front preservation: shows how an assessment of the existing situation is important in deciding the most appropriate approach. The picture shows a well-preserved, good quality traditional shop-front. The conversion to residential use has successfully preserved the whole of this frontage, which also allows a lot of natural light into the building. Early consultation with council officers on the most approach is recommended.

Sometimes the most appropriate approach is to preserve a good quality shop front.



Example 1: Shop front preservation

8.5. Conversions to residential use



Example 2: Revert back to original



Example 2 Reverting Back to an Original House Frontage: is an indicative example of where an original house had in the past been converted to a shop. If this was to revert back to residential use, the most appropriate approach would be to restore it to its original residential appearance by reinstating the bay window.

Example 3 Assessment of Former Shopping Parade Converted to Residential : This shows a former parade of five shops that have all been converted to residential use. These have been done at different times, with varying degrees of success. This serves well to show how, what may seem small aspects of design, can significantly affect the successful appearance of the façade.



- b** The brick colour and red-brick banding are not sufficiently accurate to the host building or units 1 & 2
- w** The window height is too small
- p** The position of the window needs to be aligned with the upper floor windows
- r** The door should have a recess
- d** In unit 5, the door (not seen) should be on the corner, and not from the side street

8.6. Glossary

A2 use - office use for financial and professional services (i.e. accountancy, law practice etc.)

Abrasion resistant - ability of a material to resist surface wear

Art Deco - an architectural style common during the early 20th century using organic motives as decorative features

Awning box - The boxing in which an awning retracts into, usually timber or aluminum

Branding identity - the visual elements of a business, for example colours, logo, name and symbol which all help to identify the company in the consumers mind

Building envelope The elements that enclose the building, i.e. walls, roofs, windows and doors.

Building typologies - Types of buildings

C20 buildings - A building designed and built in the 20th century

Coherent - forming a unified whole

Consonance - agreement or compatibility between opinions or actions

Conservation area - an area of notable environmental or historical interest or importance which is protected by law against undesirable changes

Convenience retail - shops that serve everyday needs, i.e. a grocer or newsagent

Cornicing - a horizontal decorative moulding that crowns the top of the shopfront

Cultural identity - is the distinct identity of a place brought about by many factors including nationality, religion, generation, locality and social groups

Curved vitrine displays - a display cabinet with curved glass

D2 use - community use for health or child care (i.e. surgery, nursery etc.)

Dilapidation - the state or process of falling into decay or being in disrepair

Exposed Bressumer - an exposed load bearing beam over a shopfront. a bressumer can be made from timber, iron or steel

Fascia - a signboard on the upper part of the shop which displays the name of the shop.

Fanlight - a small semicircular or rectangular opening over a door or above another window

Fluctuant Entity - something which is constantly changing

Forecourts - immediate area in front of the shop

Glazing bars - a bar or rigid supporting strip between adjacent panes of glass

Hostile appearance - unappealing and uninviting in appearance

LED festoons - a string of lamps wired to a flexible cable

Legible - it is clear enough to read

Longevity - the length of an objects life

Mixed-use development - buildings that contain a number of uses, combining residential with retail and or/office or workshop uses

Party wall - a wall common to two adjoining buildings

Parapet - a low protective wall on the edge of a roof

Pilaster - A rectangular column projecting from the wall usually located on the dividing line between two building

Primer - a substance used as a preparatory coat on wood, metal, or canvas, especially to prevent the absorption of subsequent layers of paint or the development of rust

Projecting sign - a sign attached to the face of a building projecting outwards usually connected to the facade with ironmongery.

Rainwater goods - pipes, gutters or hoppers intended for the collection and discharge of rainwater from buildings

Recessed - set back from the surface it is attached to

Render - a coat of plaster or sand/cement render applied to a brick or stone surface

Repointing of Brickwork - repointing is the process of renewing the 'pointing, which is the external part of mortar joints in masonry construction.

Socio-economic context - Relating to both social and economic factors

Specification - a detailed description of the design and materials used to make something

Stall riser - a low wall below the shopfront, can be made from timber or masonry

Statutory obligations - statutory obligations are those obligations that do not arise out of a contract, but are imposed by law

Stucco - a fine plaster used in coating wall surfaces or moulding architectural decorations

Timber mullion - A vertical element which forms a division between panels of glass in a window or door.

Transoms - a transom is a horizontal structural beam or bar, or a crosspiece separating a door from a window above it.

Vinyl lettering - individual, self-adhesive letters often applied to the inside of glazing in shops

Further contact:

Future Merton

9th Floor

Merton Civic Centre

London Road

Morden

SM4 5DX

Telephone: 020 8545 3837 or 020 8545 4141

Email: future.merton@merton.gov.uk

Shop front Guide

Commissioned by the London Borough of Merton

Written, drawn and produced by:



Dr Jan Kattein

Diogo Real

Gareth Marriott

Heloise Desaissement

Alice Hardy

© Copyright October 2016

