

# Merton Parking Services

## Enforcement Policy

---

February 2020



# Table of Contents

---

Parking Legislation.....	5
Exempt Vehicles.....	6
Blue Badges.....	9
Enforcement Protocol.....	10
Footway parking policy.....	14
On-Street contraventions (updated Sep-17) .....	15
01 - Parked in a restricted street during prescribed hours.....	15
01 - Exemptions to enforcement.....	16
02 - Parked or loading/unloading in a restricted street where waiting and loading/unloading restrictions are in force.....	17
02 - Exemptions to enforcement.....	18
05 - Parked after the expiry of paid for time .....	19
05 - Exemptions to enforcement.....	20
06 - Parked without clearly displaying a valid pay and display ticket or voucher.....	21
06 - Exemptions to enforcement.....	22
07 - Parked with payment made to extend the stay beyond initial time .....	23
07 - Exemptions to enforcement.....	24
11u - Parked without payment of the parking charge (electronic payment) .....	25
11u - Exemptions to enforcement .....	26
12 - Parked in a residents' or shared use parking place or zone without either clearly displaying a valid permit or voucher or pay and display ticket issued for that place, or without payment of the parking charge .....	27
12 - Exemptions to enforcement.....	28
14 - Parked in an electric vehicles charging place during restricted hours without charging.....	29
14 - Exemptions to enforcement.....	30
16 - Parked in an permit space without displaying a valid permit.....	31

16 - Exemptions to enforcement.....	32
19 - Parked in a residents' or shared use parking place or zone either displaying an invalid permit or voucher or pay and display ticket, or after the expiry of paid for time.....	33
19 - Exemptions to enforcement.....	34
21 - Parked wholly or partly in a suspended bay or space.....	35
21 - Exemptions to enforcement.....	36
22 - Re-parked in the same parking place or zone within one hour after leaving .....	37
22 - Exemptions to enforcement.....	38
23 - Parked in a parking place that is not designated for that class of vehicle.....	39
23 - Exemptions to enforcement.....	40
24 - Not Parked correctly within the markings of the bay or space .....	41
24 - Exemptions to enforcement.....	42
25 - Parked in a loading place during restricted hours without loading.....	43
25 - Exemptions to enforcement.....	44
26 - Parked in a special enforcement area, not within a designated parking place, more than 50cm from the edge of a carriageway.....	45
26 - Exemptions to enforcement.....	46
27 - Parked in a special enforcement area adjacent to a footway, cycle track or verge lowered to meet the level of the carriageway.....	47
27 - Exemptions to enforcement.....	48
28 - Parked in a special enforcement area on part of the carriageway raised to meet the level of a footway, cycle track or verge.....	49
28 - Exemptions to enforcement.....	50
30 - Parked longer than permitted .....	51
30 - Exemptions to enforcement.....	52
40 - Parked in a designated disabled person's parking place without displaying a valid disabled person's badge in the prescribed manner.....	53
40 - Exemptions to enforcement.....	54
45 - Stopped on a Taxi Rank.....	55
45 - Exemptions to enforcement.....	56
47 - Stopped on a restricted bus stop or stand.....	57
47 - Exemptions to enforcement.....	58

48 - Stopped in a restricted area outside a school, a hospital or a fire, police or ambulance station when prohibited.....	60
48 - Exemptions to enforcement.....	61
49 - Parked wholly or partly on a cycle track or lane .....	62
49 - Exemptions to enforcement.....	63
55 - A commercial vehicle parked in a restricted street in contravention of the Overnight Waiting Ban.....	64
55 - Exemptions to enforcement.....	65
61 - A heavy commercial vehicle wholly or partly parked on a footway, verge or land between two carriageways.....	66
61 - Exemptions to enforcement.....	63
62 - Parked with one or more wheels on or over a footpath or any part of the road other than a carriageway .....	64
62 - Exemptions to enforcement.....	65
99 - Stopped on a pedestrian crossing or crossing marked by zigzags.....	67
99 - Exemptions to enforcement.....	68
Off-Street contraventions (updated Sep-17).....	69
82 - Parked after the expiry of paid for time .....	69
83 - Parked in a car park without clearly displaying a valid pay & display ticket or voucher or parking clock.....	70
84 - Parked with payment made to extend the stay beyond initial time .....	71
86 - Not parked correctly within the markings of a bay or space.....	72
85 - Parked without clearly displaying a valid permit where required .....	73
87 - Parked in a designated disabled person's parking place without displaying a valid disabled person's badge in the prescribed.....	74
90 - Re-parked in a car park within one hour after leaving.....	75
91 - Parked in a car park or area not designated for that class of vehicle .....	76
92 - Parked in a car park causing an obstruction .....	77
Contravention codes (version 6.7.3).....	78
Suffixes.....	80

# Parking Legislation

This manual should be used in conjunction with the following legislation:

## **Road Traffic Regulation Act 1984**

- Extensive legislation covering Road Traffic including the power to create Traffic
- Orders and charge for parking

## **Traffic Management Act 2004**

- Primary legislation covering decriminalized parking enforcement

## **Civil Enforcement of Parking Contraventions (England) General Regulations 2007**

- Covers procedures for issuing and enforcing penalty charges

## **Civil Enforcement of Parking Contraventions (England) Representations and Appeals Regulations 2007**

- Contains appeals and representation procedures

## **Greater London (General powers) Act 1974 (amended by the London Local Authorities and Transport for London Act 2008)**

- Footway parking legislation

## **London Local Authorities Acts 2000, 2003, 2008**

- Various additional parking powers given to London Councils

## **The Disabled Persons (Badges for Motor Vehicles) (England) Regulations 2000**

- Blue badge regulations (amended in 2007)

## **Traffic signs Regulations and General Directions 2002 ('TSRGD')**

- Signs and road markings legislation

All parking legislation is available on the [www.legislation.gov.uk](http://www.legislation.gov.uk) website

Local parking restrictions are defined in Traffic Management Orders (TMOs) made by the Council. These are available on request – please contact Traffic and Highways on [0208545 3700](tel:02085453700).

# Exempt Vehicles

## **The following classes of vehicle are exempt borough wide**

### **Cash in transit vehicles (CITV)**

Whilst not exempt in the TMO, Merton policy in line with London Councils guidance is to permit CITV vehicles to wait on all restrictions. PCNs will only be issued to CITV on the instruction of a senior enforcement officer.

### **Emergency Vehicles**

Fire, Police and London Ambulance are always exempt from all restrictions if on official duty. Patient transport ambulances should be treated as a minibus unless displaying a blue badge. Police unmarked vehicles should display log book if parked. If the vehicle is deemed to be 'off-duty' a PCN should only be issued if the vehicle is parked causing an obstruction and full notes made. Vehicles transporting human blood or organs are exempt.

### **Military vehicles**

Vehicles used by any armed forces are exempt from all restrictions.

### **Royal Mail**

As the universal service provider for mail services in the UK Royal Mail liveried vehicles are exempt from all restrictions whilst carrying out their statutory duties. This does NOT include Parcel Force, DHL, UPS etc. as these are commercial companies who do not deliver mail as a universal service provider.

### **Funeral Vehicles**

Vehicles actively involved in a funeral service will not be issued with a PCN.

### **Glazing vehicles**

Vehicles carrying out emergency works are permitted to wait on yellow lines including loading restrictions whilst carrying out works if no legitimate parking place adjacent to the works is available. This does not apply to any persons carrying out general glazing including 'double glazing' works who are required to park lawfully once loading or unloading has taken place.

### **Utilities vehicles**

Most Merton TMOs allow a vehicle to wait for the purpose of:

Any building operation, demolition or excavation adjacent to the parking place

The maintenance, improvement or reconstruction of the highway

The cleansing of gullies in or adjacent to the parking place

The laying, erection alteration or repair in or adjacent to the parking place of any sewer or of any main, pipe or apparatus for the supply of gas, water or electricity or of any telecommunication system

The placing, maintenance or removal of any traffic sign

Therefore vehicles carrying out works in the street to cables, pipes, sewers etc. are exempt as are vehicles such as cranes and diggers used to carry out building works. Passenger vehicles are not exempt.



Vehicles carrying out commercial servicing and

Repairs inside premises are NOT exempt. Some companies such as Virgin Media and BT carry out both services.

### **Gas, Water and Electricity**

Unless the vehicle is being used by a utilities provider such as Thames Water, UK power networks, Southern Gas networks or one of their contractors it is not exempt. EDF Energy, British Gas and other local suppliers of electricity and gas should be treated like any other plumbing or electrical service and issued a PCN if parked in contravention and if they wish to claim an exemption they can challenge the PCN in writing. This includes vehicles with notes claiming 'gas emergency' etc.

Drain servicing and jetting vehicles carrying out work to underground drains and sewers are exempt whilst servicing adjacent properties.

### **Health Emergency Badge (HEB) holders**

London Councils Transport and Environment Committee and the London boroughs operate a parking scheme for doctors and others involved in primary health care in the capital. The badge is called the Health Emergency Badge (HEB).

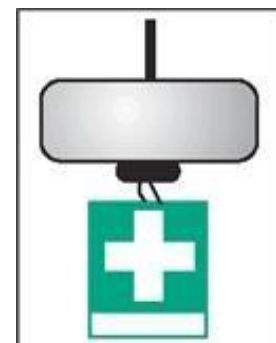

The badge can only be used when visiting a patient to provide emergency healthcare and should be clearly displayed on the rear view mirror with the visiting address. The vehicle should be near the address displayed if used correctly.

Badge users can park in meter bays and pay and display bays without paying. They can also use bays reserved for residents or some other purposes, if necessary and on yellow lines if no other spaces exist.

The badge does not apply if the vehicle is causing a serious obstruction and cannot be used for routine home visits.

Parking outside hospitals and clinics and parking on doctors bays is not permitted.

### **Motorcycles**



Motorcycles may park free in any motorcycle, permit, shared use or P&D bay or car park without charge, maximum stay or conditions. They are not exempt from any other restrictions including footway parking. When dealing with motorcyclists seeking parking advice they should be directed to the nearest parking place least likely to cause inconvenience to other road users and preferably a dedicated motorcycle bay.

### **Statutory Duties**

Council vehicles carrying essential statutory duties are exempt from certain restrictions these exemptions are contained within the Traffic Management orders. Where applicable these exemptions will be stated in the 'Contraventions' section of this manual.



# Blue Badges

The Blue Badge scheme is for people with severe mobility problems. These may include physical or mental health problems. It allows Blue Badge holders to park close to where they need to go. The scheme operates throughout the UK and is managed by local authorities, who deal with applications and issue Blue Badges.

In Merton Blue Badges are valid on all permitted parking places and on yellow lines for 3 hours in line with the Blue Badge guidelines.

They do not exempt the Blue Badge holder from parking on loading restrictions, Loading only bays, Car Club bays, Motorcycle bays, footways or any stopping restrictions, dropped kerbs and parking out of bay.

## EU Badges are valid in the UK

Badges must be displayed non photo side up, clearly displaying expiry date and hologram. Rear of personal badges should have photo of holder. Organizational badges are issued to charities, carers, homes etc. and may only be used to carry clients and not for the drivers own personal use.

CEO's may request to inspect Blue badges and have the authority to confiscate under the Road Traffic Act 1984 and the Disabled Person Parking Badges Act 2013 if they believe that misuse has occurred. It is a criminal offence to refuse to produce a blue badge for inspection if requested.



# Enforcement Protocol

## Abandoned vehicles

If a car has 5 or more PCNs issued for the same location the vehicle should be reported as a possible stolen/abandoned vehicle. Any officer issuing to the vehicle should check on return to the office that it has been logged in the abandoned vehicle file. There is no limit to the number of PCNs that can be issued to one vehicle. Untaxed vehicles may in addition to this be reported to the DVLA directly or [www.merton.gov.uk/streets-parking-transport/abandoned-vehicles](http://www.merton.gov.uk/streets-parking-transport/abandoned-vehicles)

## Multiple contraventions

A vehicle that remains parked for more than one contravention should be issued a PCN for each contravention. For example if a car with no P&D ticket or an expired P&D ticket remains parked when the restriction changes to no loading or unloading a second PCN can be issued.

## Differential parking

The aim behind the differential charges is to make the system fairer by imposing a greater penalty on people who park where parking is not generally permitted (e.g. on a yellow line or school "Keep Clear" marking), and on those who park, for example, in a bay for residents permit holders or disabled people without displaying the appropriate permit or badge. If a vehicle has contravened more than one regulation then the most appropriate code should be used, not necessarily the highest. CEOs should choose the contravention that has the best evidence available.

## Moving on

If a vehicle is parked on a waiting or loading restriction with the driver in the vehicle providing the driver is awake they should be spoken to in order to determine if any exempt activity is taking place this includes an '02' contravention where boarding and alighting is permitted. If no lawful reason to remain parked is given or observed the driver should be moved on and if failing to do so a PCN issued if appropriate.

If the restriction is 'no stopping' e.g. a bus stop or zig zag the PCN can be issued instantly.

### **Observation periods**

An observation period is the time spent observing a vehicle to determine if a contravention has taken place. The observation period is not a grace period; any vehicle deemed to be contravening before the observation has ended should be moved on if possible. It is not acceptable for CEOs to inform drivers that they can park in contravention to go into shops etc.; they should be directed to a legitimate parking place.

### **Constant observation**

Any observation under 20 minutes should include at least 2 minutes recorded constant observation and the vehicle in sight the entire time to observe any exempt activity. Other vehicles in the vicinity can be checked but leaving the street and returning after 5 minutes is not an 'observation'.

### **Casual observation**

Periods over 20 minutes can be carried out using casual observations with the vehicle observed casually over a longer period of time.

### **Start times**

When a restriction is starting in a permit or shared use bay 10 minutes leeway should be used as it's possible the driver may consider they have parked legally: e.g. 8.30 permit bays would not be enforced before 8.40.

### **Change of restriction times**

When a restriction changes from one type to another no leeway should be used as it can be expected the driver should be aware of a change of restriction when they first parked.

## End times

When a restriction changes from controlled to free parking a PCN will not be commenced less than 5 minutes before the end e.g. a permit bay restriction ends at 1830, a PCN will not be commenced after 1825. However if a PCN has been commenced before 1825 and is an instant issue or requires an observation period it can be issued after this time but before the end.

## Grace periods

If a vehicle is parked legally on a designated parking bay when it is initially parked, we will apply a 10 minute grace period before issuing a PCN from the moment it becomes parked illegally.

This means that we will not issue a PCN until 10 minutes have passed after the expiry of a pay & display ticket or **RingGo** session. The grace period also applies to free parking places.

The grace period does not apply to yellow lines or any other area where parking is not permitted.

## **London Councils has produced the following guidance about other circumstances in which the grace period will or will not apply:**

A 10 minute grace period will apply to a vehicle not displaying a permit that is parked on a residents bay when controls are not in force (and the vehicle is allowed to park) from the moment controls commence.

A 10 minute grace period will not apply to a vehicle that is parked on a permit bay, shared use bay or pay and display bay when controls are already in force, and the driver does not display a permit/scratch card or pay and display ticket. (Please note that any usual observation periods will still apply).

A 10 minute grace period will not apply to a vehicle parked outside the hours of control on a single yellow line (and not in a designated parking place) when controls commence. (Please note that any usual observation periods will still apply).

A 10 minute grace period will not apply to a vehicle parked in a bay that is not designated for that class of vehicle if it parks when controls are already in force. (Please note that any usual observation periods will still apply).

A 10 minute grace period will apply if a vehicle parked in a bay not designated for that class of vehicle is legally parked when controls are not in force (and the vehicle is allowed to park) from the moment controls commence.

A 10 minute grace period will not apply to a vehicle parked on a yellow line displaying a blue badge if parked for longer than the maximum 3 hour period.

A 10 minute grace period will apply to a vehicle displaying a blue badge that is parked on a blue badge bay for longer than any stipulated time period.

## Footway parking policy

We will enforce against vehicles that are parked on the pavement where there is sufficient room (width) on the highway to park and vehicles such as Fire Engines and Refuse vehicles have enough room to pass.

Where there is insufficient width in the road to allow Refuse vehicles and Fire Engines to pass, footway parking will be allowed on the pavement but with the following caveats:

Parking on the grass verges will not be allowed under any circumstances due to the cost to the Council in repairing damaged verges

When parking on the pavement is allowed a **minimum gap of one metre** must be left on the pavement from the building line to the vehicle to allow Wheel Chair users and **pedestrians** to pass the vehicle.



The Council reserves to right to change (include or remove) the roads affected by this policy

Failure to comply with above (1 and 2) will mean vehicles will be issued with a Penalty Charge Notice.

The full policy and the affected roads list can be found on the Merton Council website.

This policy does not apply in streets that have designated footway parking bays and signs indicating the start and end of permitted footway parking.

In a CPZ all parking on the highway outside of marked bays is prohibited therefore footway parking should be enforced without the need for complaints or warning notices even outside of CPZ hours.

# On-Street contraventions (updated Sep-17)

## 01 - Parked in a restricted street during prescribed hours

The contravention occurs when a vehicle waits during the prescribed hours in a restricted street (i.e. on a yellow line)

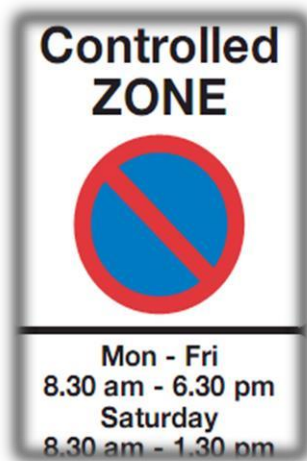
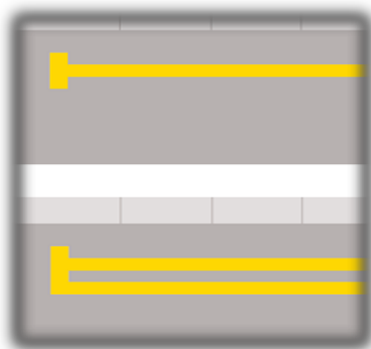

### Extra information to be recorded:

- Details of yellow lines
- CPZ zone
- Details of kerbside plates

### Loading/unloading allowed:

Yes

### Observation period:

Yes

### Notes:

- Time plates are not required in CPZs except where the times of restriction differ from the CPZ hours
- Time plates are not required on double yellow lines

### Suffixes:

- a = Temporary traffic order
- o = Blue Badge holder
- y = Obscured Blue badge
- z = Expired Blue Badge

## **01 - Exemptions to enforcement**

Vehicles parked in connection with loading/unloading activity. The maximum time permitted for this activity is 20 minutes

Vehicles carrying out domestic or commercial removals

For as long as is necessary to pick up or set down passengers. The driver should remain with the vehicle unless assisting young or disabled passengers

Whilst displaying a valid Blue Badge

Whilst it is evident to the CEO that a security gate/barrier at the entrance to premises, to which the vehicle requires access to or from which it has emerged, is being opened or closed, in circumstances when no other practical waiting area available

When a valid dispensation is clearly displayed within the vehicle whilst the vehicle is parked within

Royal Mail used in conjunction with the carriage of mail under their universal postal license and as such attract an exemption whereby there is no time limit.

Local Authority vehicles carrying out statutory duties

Vehicles considered to be parked for ambulance purposes, police purposes, or fire brigade purposes

Vehicles parked for the purpose of erecting or dismantling scaffolding

Vehicles being used in connection with works on the carriageway that constitutes an exemption under the New Road and Street Works Act (1991)

Vehicles clearly displaying a valid Health Emergency Badge in accordance with the conditions of use.

Council vehicles carrying essential statutory duties are exempt from certain restrictions these exemptions are contained within the Traffic Management orders.



## **02 - Parked or loading/unloading in a restricted street where waiting and loading/unloading restrictions are in force**

The contravention occurs when a vehicle waits or loads/unloads during prescribed hours in a street where there are loading/unloading restrictions as well as waiting restrictions



### **Extra information to be recorded:**

Details of yellow lines and stripes on kerbs

Details of kerbside plates

### **Loading/unloading allowed:**

No

### **Observation period:**

No

### **Suffixes:**

a = temporary traffic order

= Blue Badge holder

## **02 - Exemptions to enforcement**

For as long as is necessary to pick up or set down passengers. The driver should remain with the vehicle unless assisting young or disabled passengers

Whilst it is evident to the CEO that a security gate/barrier at the entrance to premises to which the vehicle requires access to, or from which it has emerged, is being opened or closed, in circumstances when no other practical waiting area available

When a valid dispensation is clearly displayed within the vehicle whilst the vehicle is parked within the confines granted

Royal Mail used in conjunction with the carriage of mail under their universal postal license and as such attract an exemption whereby there is no time limit

Local Authority vehicles carrying out statutory duties

Vehicles considered to be parked for ambulance purposes, police purposes, or fire brigade purposes

Vehicles parked for the purpose of erecting or dismantling scaffolding

Vehicles being used in connection with works on the carriageway that constitutes an exemption under the New Road and Street Works Act (1991)

Glazing vehicles carrying out emergency glazing works

## **05 - Parked after the expiry of paid for time**

The contravention occurs when a vehicle waits in a parking bay during controlled hours and the purchased time has expired



### **Extra information to be recorded:**

Extra time on pay and display ticket or electronic payment

### **Loading/unloading allowed:**

Yes

### **Observation period:**

10 Minutes after expiry of paid for time

### **Note:**

PCN should not be issued until a 10 minute grace period has expired  
Code should only be used on paid for tickets.

### **Suffixes:**

p = pay and display bay

s = shared use bay

u = electronic payment

## **05 - Exemptions to enforcement**

Vehicles parked in connection with loading/unloading activity. The maximum time permitted for this activity is 20 minutes

Vehicles carrying out removals from domestic or commercial properties

Whilst displaying a valid Blue Badge

For as long as is necessary to pick up or set down passengers. The driver should remain with the vehicle unless evidence of assisting young or disabled passengers

When a valid dispensation is clearly displayed within the vehicle whilst the vehicle is parked within the confines granted

Royal Mail vehicles delivering or collecting items of post

Local Authority vehicles carrying out statutory duties

Vehicles considered to be parked for ambulance purposes, police purposes, or fire brigade purposes

Vehicles parked for the purpose of erecting or dismantling scaffolding

Vehicles being used in connection with works on the carriageway that constitutes an exemption under the New Road and Street Works Act (1991)

Any non-passenger vehicle being used for the purpose of any building operation, demolition or excavation adjacent to the parking place, the maintenance, improvement or reconstruction of the road or the cleansing of gullies in or adjacent to the parking place, the laying, erection, alteration, removal or repair in or adjacent to the parking place or any sewer or of any main, pipe or apparatus for the supply of gas, water or electricity or of any telecommunication apparatus as defined in the Telecommunications Act 1984 or the placing, maintenance or removal of any traffic sign

Vehicles clearly displaying a valid Health Emergency Badge in accordance with the conditions of use

## **06 - Parked without clearly displaying a valid pay and display ticket or voucher**

The contravention occurs when a vehicle waits in a pay and display bay during controlled hours and a valid ticket has not been clearly displayed in the vehicle or electronic payment has not been made.

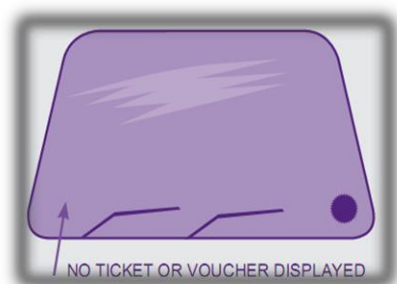

### **Extra information to be recorded:**

Details of any invalid tickets or permits displayed

Confirmation machine checked

Electronic payment checked

### **Loading/unloading allowed:**

Yes

### **Observation period:**

No

### **Suffixes:**

p = pay and display bay

## **06 - Exemptions to enforcement**

Vehicles parked in connection with loading/unloading activity. The maximum time permitted for this activity is 20 minutes

Vehicles carrying out removals from domestic or commercial properties

Whilst displaying a valid Blue Badge

For as long as is necessary to pick up or set down passengers. The driver should remain with the vehicle unless evidence of assisting young or disabled passengers

When a valid dispensation is clearly displayed within the vehicle whilst the vehicle is parked within the confines granted

Royal Mail vehicles delivering or collecting items of post

Local Authority vehicles carrying out statutory duties

Vehicles considered to be parked for ambulance purposes, Police purposes, or Fire brigade purposes

Vehicles parked for the purpose of erecting or dismantling scaffolding

Vehicles being used in connection with works on the carriageway that constitutes an exemption under the New Road and Street Works Act (1991)

Any non-passenger vehicle being used for the purpose of any building operation, demolition or excavation adjacent to the parking place, the maintenance, improvement or reconstruction of the road or the cleansing of gullies in or adjacent to the parking place, the laying, erection, alteration, removal or repair in or adjacent to the parking place or any sewer or of any main, pipe or apparatus for the supply of gas, water or electricity or of any telecommunication apparatus as defined in the Telecommunications Act 1984 or the placing, maintenance or removal of any traffic sign

Vehicles clearly displaying a valid Health Emergency Badge in accordance with the conditions of use

## **07 - Parked with payment made to extend the stay beyond initial time**

The contravention occurs when a vehicle remains in a parking bay beyond the expiry time by extending that time with extra payment



### **Extra information to be recorded:**

#### **1st observation:**

- Time of observation
- V  
R  
M

P&D ticket details/Electronic payment

Vehicle valve positions

#### **2<sup>nd</sup> observation:**

Valve positions to match those made on first observation

Details of extra ticket purchased

Max stay of bay

### **Loading/unloading allowed:**

Not applicable

### **Observation period:**

None required at second observation

### **Notes:**

Merton policy permits meter feeding unless:

Max stay is exceeded

Driver gains financially due to tariff change

### **Suffixes:**

p = pay and display bay

s = shared use bay

## **07 - Exemptions to enforcement**

Vehicles parked in connection with loading/unloading activity. The maximum time permitted for this activity is 20 minutes.

Whilst displaying a valid Blue Badge

For as long as is necessary to pick up or set down passengers. The driver should remain with the vehicle unless evidence of assisting young or disabled passengers

When a valid dispensation is clearly displayed within the vehicle whilst the vehicle is parked within the confines granted

Royal Mail vehicles delivering or collecting items of post, under their universal postal license and as such still attract an exemption whereby there is no time limit

Local Authority vehicles carrying out statutory duties

Vehicles considered to be parked for ambulance purposes, police purposes, or fire brigade purposes

Vehicles parked for the purpose of erecting or dismantling scaffolding

Vehicles being used in connection with works on the carriageway that constitutes an exemption under the New Road and Street Works Act (1991)

Any non-passenger vehicle being used for the purpose of any building operation, demolition or excavation adjacent to the parking place, the maintenance, improvement or reconstruction of the road or the cleansing of gullies in or adjacent to the parking place, the laying, erection, alteration, removal or repair in or adjacent to the parking place or any sewer or of any main, pipe or apparatus for the supply of gas, water or electricity or of any telecommunication apparatus as defined in the Telecommunications Act 1984 or the placing, maintenance or removal of any traffic sign

Vehicles clearly displaying a valid Health Emergency Badge in accordance with the conditions of use



## **11u - Parked without payment of the parking charge (electronic payment)**

The contravention occurs when a vehicle waits in a parking place during controlled hours without making payment

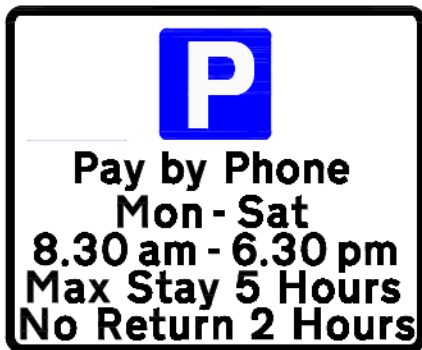

### **Extra information to be recorded:**

RingGo Checked

### **Loading/unloading allowed:**

Not applicable

### **Observation period:**

None

### **Suffixes:**

u = electronic payment

## **11u - Exemptions to enforcement**

- Vehicles parked in connection with loading/unloading activity. The maximum time permitted for this activity is 20 minutes
- Vehicles carrying out removals from domestic or commercial properties
- Whilst displaying a valid Blue Disabled Badge
- For as long as is necessary to pick up or set down passengers. The driver should remain with the vehicle unless evidence of assisting young or disabled passengers
- When a valid dispensation is clearly displayed within the vehicle whilst the vehicle is parked within the confines granted
- Royal Mail vehicles delivering or collecting items of post
- Local Authority vehicles carrying out statutory duties
- Vehicles considered to be parked for ambulance purposes, Police purposes, or Fire brigade purposes
- Vehicles parked for the purpose of erecting or dismantling scaffolding
- Vehicles being used in connection with works on the carriageway that constitutes an exemption under the New Road and Street Works Act (1991)
- Any non-passenger vehicle being used for the purpose of any building operation, demolition or excavation adjacent to the parking place, the maintenance, improvement or reconstruction of the road or the cleansing of gullies in or adjacent to the parking place, the laying, erection, alteration, removal or repair in or adjacent to the parking place or any sewer or of any main, pipe or apparatus for the supply of gas, water or electricity or of any telecommunication apparatus as defined in the Telecommunications Act 1984 or the placing, maintenance or removal of any traffic sign
- Vehicles clearly displaying a valid Health Emergency Badge in accordance with the conditions of use

## **12 - Parked in a residents' or shared use parking place or zone without either clearly displaying a valid permit or voucher or pay and display ticket issued for that place, or without payment of the parking charge**

The contravention occurs when a vehicle waits in a permit bay during controlled hours and fails to display any permit issued **for that parking place**

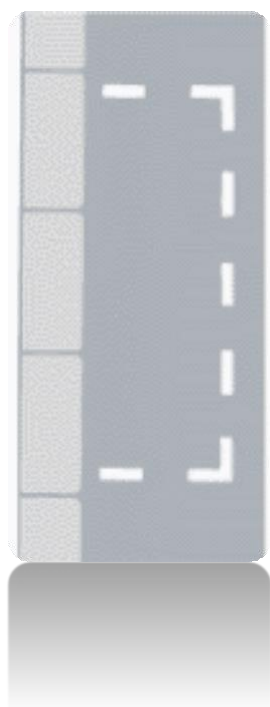

### **Extra information to be recorded:**

Details of any pay and display tickets, permits or vouchers displayed, with reasons why they are invalid for that place

### **Loading/unloading allowed:**

Yes

### **Observation period:**

Yes

### **Notes:**

If an invalid permit for that zone is displayed then code 19 should be issued

### **Suffixes:**

r,s,t,u,w,y,z

## **12 - Exemptions to enforcement**

Vehicles parked in connection with loading/unloading activity. The maximum time permitted for this activity is 20 minutes

Vehicles carrying out removals from domestic or commercial properties

Whilst displaying a valid Blue Badge

For as long as is necessary to pick up or set down passengers. The driver should remain with the vehicle unless evidence of assisting young or disabled passengers

When a valid dispensation is clearly displayed within the vehicle whilst the vehicle is parked within

Royal Mail vehicles delivering or collecting items of post

Local Authority vehicles carrying out statutory duties

Vehicles considered to be parked for ambulance purposes, police purposes, or fire brigade

Vehicles parked for the purpose of erecting or dismantling scaffolding

Vehicles being used in connection with works on the carriageway that constitutes an exemption

Any non-passenger vehicle being used for the purpose of any building operation, demolition or excavation adjacent to the parking place, the maintenance, improvement or reconstruction of the road or the cleansing of gullies in or adjacent to the parking place, the laying, erection, alteration, removal or repair in or adjacent to the parking place or any sewer or of any main, pipe or apparatus for the supply of gas, water or electricity or of any telecommunication apparatus as defined in the Telecommunications Act 1984 or the placing, maintenance or removal of any traffic sign

Vehicles clearly displaying a valid Health Emergency Badge in accordance with the conditions of use

# **14 - Parked in an electric vehicles charging place during restricted hours without charging**

The contravention occurs in Merton when a vehicle parks in an Electric Vehicle Parking Bay without charging taking place



### **Loading/unloading allowed:**

No

### **Observation period:**

No

### **Exemptions:**

council/government statutory duties

emergency services

road maintenance

statutory undertaking



## **14 - Exemptions to enforcement**

Drivers are allowed to pick up or set down passengers

Vehicles considered to be parked for ambulance purposes, police purposes, customs purposes or fire brigade purposes

Any non-passenger vehicle being used for the purpose of any building operation, demolition or excavation adjacent to the parking place, the maintenance, improvement or reconstruction of the road or the cleansing of gullies in or adjacent to the parking place, the laying, erection, alteration, removal or repair in or adjacent to the parking place or any sewer or of any main, pipe or apparatus for the supply of gas, water or electricity or of any telecommunication apparatus as defined in the Telecommunications Act 1984 or the placing, maintenance or removal of any traffic sign

## **16 - Parked in an permit space without displaying a valid permit**

The contravention occurs in Merton when a vehicle waits in a Car Club or Doctors permit space without displaying a valid permit

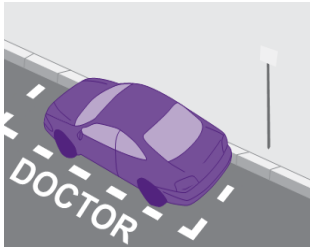

### **Extra information to be recorded:**

- Details of any pay and display tickets, permits or vouchers displayed, with reasons why they are invalid for that place

### **Loading/unloading allowed:**

- No

### **Observation period:**

- No

### **Suffixes:**

- d = doctors' bay
- e = car club bay
- t = P&D ticket used
- y = obscured/illegible permit
- z = out of date permit

## **16 - Exemptions to enforcement**

- Vehicles displaying the relevant, valid permit or document
- For as long as is necessary to pick up or set down passengers. The driver should remain with the vehicle unless evidence of assisting young or disabled passengers
- When a valid dispensation is clearly displayed within the vehicle whilst the vehicle is parked within the confines granted
- Royal Mail vehicles delivering or collecting items of post, under their universal postal license and as such still attract an exemption whereby there is no time limit
- Local Authority vehicles carrying out statutory duties
- Vehicles considered to be parked for ambulance purposes, police purposes, or fire brigade purposes
- Any non-passenger vehicle being used for the purpose of any building operation, demolition or excavation adjacent to the parking place, the maintenance, improvement or reconstruction of the road or the cleansing of gullies in or adjacent to the parking place, the laying, erection, alteration, removal or repair in or adjacent to the parking place or any sewer or of any main, pipe or apparatus for the supply of gas, water or electricity or of any telecommunication apparatus as defined in the Telecommunications Act 1984 or the placing, maintenance or removal of any traffic sign



## **19 - Parked in a residents' or shared use parking place or zone either displaying an invalid permit or voucher or pay and display ticket, or after the expiry of paid for time**

The contravention occurs when a vehicle waits in a permit only bay during controlled hours and displays an invalid permit for that parking place

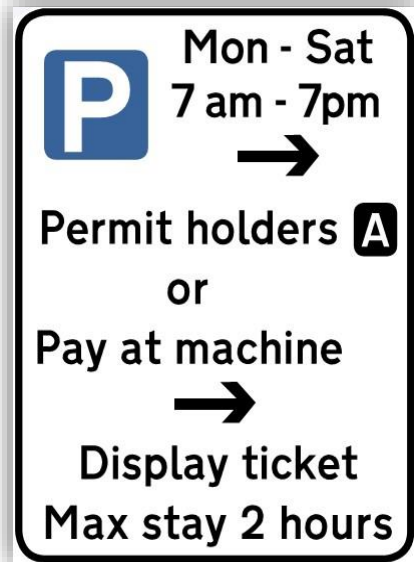

### **Extra information to be recorded:**

Details of any pay and display tickets, permits, with reasons why they are invalid for that place

### **Loading/unloading allowed:**

Yes

### **Observation period:**

Yes

### **Notes:**

Code 19 should only be issued if a permit that is or was valid for that bay is used but is invalid at time of PCN due to:

It has expired

It is in the wrong vehicle

Obscured date/ VRM

An invalid blue badge should be treated as a 19 in a permit bay

### **Suffixes:**

s = shared use bay

x = wrong VRM

y = obscured/illegible permit

## **19 - Exemptions to enforcement**

Vehicles parked in connection with loading/unloading activity. The maximum time permitted for this activity is 20 minutes

Vehicles carrying out removals from domestic or commercial properties

Whilst displaying a valid Blue Disabled Badge

For as long as is necessary to pick up or set down passengers. The driver should remain with the vehicle unless evidence of assisting young or disabled passengers

When a valid dispensation is clearly displayed within the vehicle whilst the vehicle is parked within

Royal Mail vehicles delivering or collecting items of post

Local Authority vehicles carrying out statutory duties

Vehicles considered to be parked for ambulance purposes, police purposes, or fire brigade purposes

Vehicles parked for the purpose of erecting or dismantling scaffolding

Vehicles being used in connection with works on the carriageway that constitutes an exemption under the New Road and Street Works Act (1991)

Any non-passenger vehicle being used for the purpose of any building operation, demolition or excavation adjacent to the parking place, the maintenance, improvement or reconstruction of the road or the cleansing of gullies in or adjacent to the parking place, the laying, erection, alteration, removal or repair in or adjacent to the parking place or any sewer or of any main, pipe or apparatus for the supply of gas, water or electricity or of any telecommunication apparatus as defined in the Telecommunications Act 1984 or the placing, maintenance or removal of any traffic sign

Vehicles clearly displaying a valid Health Emergency Badge in accordance with the conditions of use

## 21 - Parked wholly or partly in a suspended bay or space

The contravention occurs when a vehicle waits in a suspended parking place or in any part of a suspended parking place



### Extra information to be recorded:

Description and location of signs displayed

Details of location of vehicle in relation to suspension

Reason for suspension if known

### Loading/unloading allowed:

No

### Observation period:

No

### Suffixes:

f = free parking bay

l = loading place

p = pay and display

r = residents bay

s = shared use bay

## **21 - Exemptions to enforcement**

If the vehicle parked in the suspended area is being used in connection with the reason for the suspension, and in accordance with the terms of that suspension. For example, when spaces have been suspended for a domestic removal, a removal van may park in those spaces to carry out the relevant works. Vehicles that are not being used for the purpose of the suspension will be instantly issued with a PCN

Royal Mail vehicles delivering or collecting items of post, under their universal postal license and as such still attract an exemption whereby there is no time limit

Local Authority vehicles carrying out statutory duties

Vehicles considered to be parked for ambulance purposes, police purposes, or fire brigade purposes

Vehicles remaining parked since suspension signs erected

## 22 - Re-parked in the same parking place or zone within one hour after leaving

The contravention occurs when a vehicle leaves and re-parks in the same parking place within the prohibited time

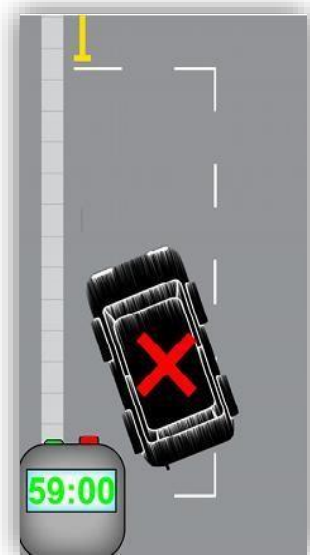
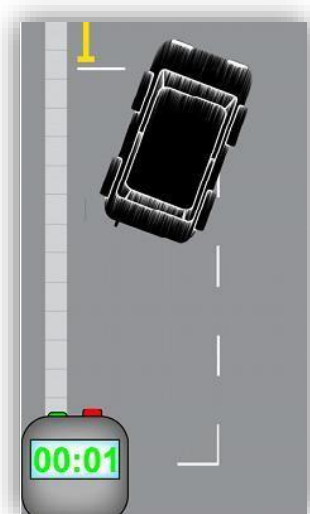

### **Extra information to be recorded:**

#### **1st observation:**

Time of observation

VRM

Vehicle valve positions

#### **2<sup>nd</sup> observation:**

VRM to match that made on first observation

Valve positions to match those made on first observation

### **Loading/unloading allowed:**

No

### **Observation period:**

Yes

### **Suffixes:**

f = free parking bay

l = loading place

p = pay and display

r = residents bay

s = shared use bay

## **22 - Exemptions to enforcement**

Vehicles parked in connection with loading/unloading activity. The maximum time permitted for this activity is 20 minutes.

Vehicles carrying out removals from domestic or commercial properties

Whilst displaying a valid Blue Badge

For as long as is necessary to pick up or set down passengers. The driver should remain with the vehicle unless assisting young or disabled passengers

When a valid dispensation is clearly displayed within the vehicle whilst the vehicle is parked within the confines granted

Royal Mail vehicles delivering or collecting items of post

Local Authority vehicles carrying out statutory duties

Vehicles considered to be parked for ambulance purposes, police purposes, or fire brigade purposes

Vehicles parked for the purpose of erecting or dismantling scaffolding

Vehicles being used in connection with works on the carriageway that constitutes an exemption under the New Road and Street Works Act (1991)

Any non-passenger vehicle being used for the purpose of any building operation, demolition or excavation adjacent to the parking place, the maintenance, improvement or reconstruction of the road or the cleansing of gullies in or adjacent to the parking place, the laying, erection, alteration, removal or repair in or adjacent to the parking place or any sewer or of any main, pipe or apparatus for the supply of gas, water or electricity or of any telecommunication apparatus as defined in the Telecommunications Act 1984 or the placing, maintenance or removal of any traffic sign

Vehicles clearly displaying a valid Health Emergency Badge in accordance with the conditions of use

## **23 - Parked in a parking place that is not designated for that class of vehicle**

The contravention occurs when a vehicle which is not of the class authorised to wait in the parking place is observed doing so during controlled hours

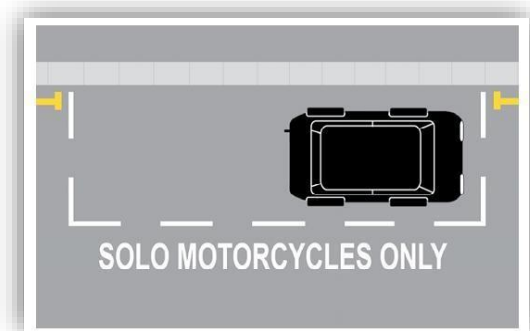

### **Extra information to be recorded:**

Details of the type of bay and class of vehicle parked

### **Loading/unloading allowed:**

Yes

### **Observation period:**

Yes

### **Suffixes:**

c = coach parking bay

g = motorcycle bay

l = loading place

z = 'good vehicles' loading bay

## **23 - Exemptions to enforcement**

Vehicles parked in connection with loading/unloading activity. The maximum time permitted for this activity is 20 minutes.

Vehicles of the specific type for which the parking place is designated

For as long as is necessary to pick up or set down passengers. The driver should remain with the vehicle unless assisting young or disabled passengers

When a valid dispensation is clearly displayed within the vehicle whilst the vehicle is parked within

Royal Mail vehicles delivering or collecting items of post, under their universal postal license and as such still attract an exemption whereby there is no time limit

Vehicles considered to be parked for ambulance purposes, police purposes, or fire brigade purposes

Local Authority vehicles carrying out statutory duties

Vehicles parked for the purpose of erecting or dismantling scaffolding

Vehicles being used in connection with works on the carriageway that constitutes an exemption under the New Road and Street Works Act (1991)

Any non-passenger vehicle being used for the purpose of any building operation, demolition or excavation adjacent to the parking place, the maintenance, improvement or reconstruction of the road or the cleansing of gullies in or adjacent to the parking place, the laying, erection, alteration, removal or repair in or adjacent to the parking place or any sewer or of any main, pipe or apparatus for the supply of gas, water or electricity or of any telecommunication apparatus as defined in the Telecommunications Act 1984 or the placing, maintenance or removal of any traffic sign

Vehicles clearly displaying a valid Health Emergency Badge in accordance with the conditions of use



## **24 - Not Parked correctly within the markings of the bay or space**

The contravention occurs when a vehicle waits in a restricted parking bay during controlled hours without being wholly within a single bay

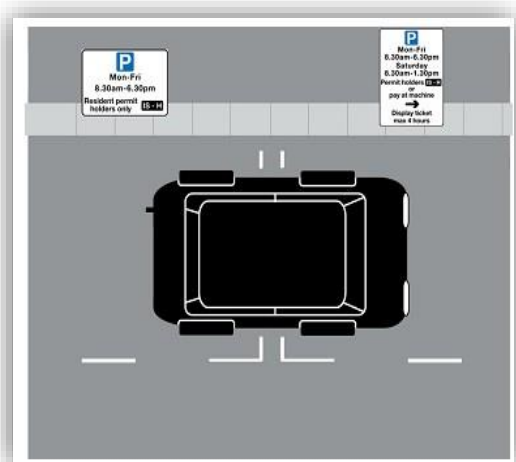
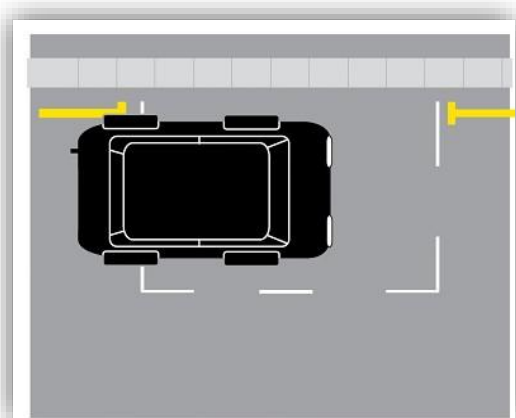

### **Extra information to be recorded:**

Details of the position of the vehicle in relation to the markings

A photograph is preferable but if dark a diagram of the parking position

### **Loading/unloading allowed:**

Yes

### **Observation period:**

Yes

No when a valid P&D is displayed

### **Notes:**

See differential parking protocol

### **Suffixes:**

f = free parking bay

p = pay and display

r = residents bay

s = shared use bay

## **24 - Exemptions to enforcement**

Vehicles parked in connection with loading/unloading activity. The maximum time permitted for this activity is 20 minutes.

For as long as is necessary to pick up or set down passengers. The driver should remain with the vehicle unless assisting young or disabled passengers

When a valid dispensation is clearly displayed within the vehicle whilst the vehicle is parked within the confines granted

Royal Mail vehicles delivering or collecting items of post, under their universal postal license and as such still attract an exemption whereby there is no time limit

Local Authority vehicles carrying out statutory duties

Vehicles considered to be parked for ambulance purposes, police purposes, or fire brigade purposes

Vehicles parked for the purpose of erecting or dismantling scaffolding

Vehicles being used in connection with works on the carriageway that constitutes an exemption under the New Road and Street Works Act (1991)

Any non-passenger vehicle being used for the purpose of any building operation, demolition or excavation adjacent to the parking place, the maintenance, improvement or reconstruction of the road or the cleansing of gullies in or adjacent to the parking place, the laying, erection, alteration, removal or repair in or adjacent to the parking place or any sewer or of any main, pipe or apparatus for the supply of gas, water or electricity or of any telecommunication apparatus as defined in the Telecommunications Act 1984 or the placing, maintenance or removal of any traffic sign

Vehicles clearly displaying a valid Health Emergency Badge in accordance with the conditions of use

## **25 - Parked in a loading place during restricted hours without loading**

The contravention occurs when a vehicle waits in a parking place designated as an on-street loading bay during restricted hours without loading or unloading taking place

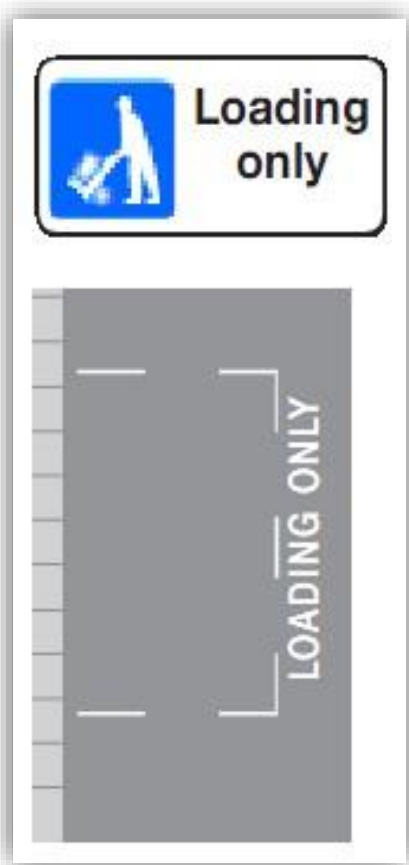

**Extra information to be recorded:**

None

**Loading/unloading allowed:**

Yes

**Observation period:**

Yes

**Notes:**

If the vehicle exceeds a signed maximum stay code 30 should be used

**Suffixes:**

## **25 - Exemptions to enforcement**

Vehicles parked in connection with loading/unloading activity. There is no maximum time permitted for this activity unless specified on time plate which if exceeded should be treated as a code 30 contravention

For as long as is necessary to pick up or set down passengers. The driver should remain with the vehicle unless assisting young or disabled passengers

When a valid dispensation is clearly displayed within the vehicle whilst the vehicle is parked within the confines granted

Royal Mail vehicles delivering or collecting items of post, under their universal postal license and as such still attract an exemption whereby there is no time limit

Local Authority vehicles carrying out statutory duties

Vehicles considered to be parked for ambulance purposes, police purposes, or fire brigade purposes

Vehicles being used in connection with works on the carriageway that constitutes an exemption under the New Road and Street Works Act (1991)

## **26 - Parked in a special enforcement area, not within a designated parking place, more than 50cm from the edge of a carriageway**

The contravention occurs when a vehicle waits more than 50cm from the edge of the carriageway and not within a designated parking place

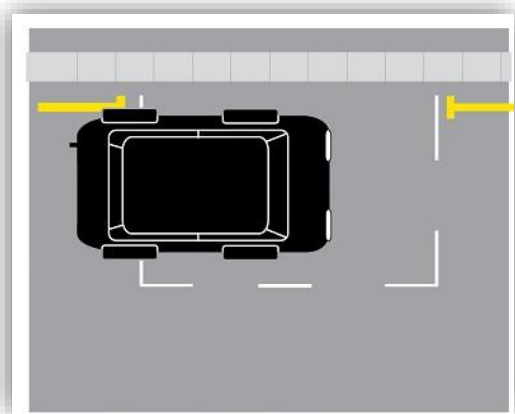

### **Extra information to be recorded:**

A diagram of the parking position. A photograph is preferable

### **Loading/unloading allowed:**

Yes

### **Observation period:**

Yes

### **Notes:**

Where a vehicle is parked partially within the markings of a bay or space, but is more than 50cm from the edge of the carriageway, code 24 should be used

The edge of the carriageway is not limited to the side of the carriageway – if there is an edge in front of or behind the vehicle then that edge must also be more than 50cm away from the vehicle

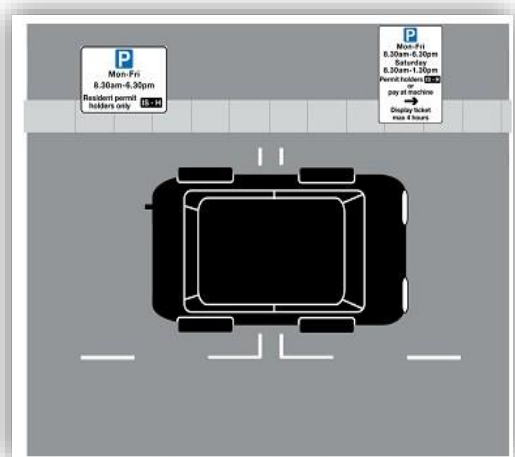

### **Suffixes:**

## **26 - Exemptions to enforcement**

Where the vehicle is parked wholly within a designated parking place or any other part of the carriageway where parking is specifically authorised

Where the vehicle is being used for fire brigade, ambulance or police purposes

Where:

- the vehicle is being used for the purposes of delivering goods to, or collecting goods from, any premises, or is being loaded from or unloaded to any premises
- the delivery, collection, loading or unloading cannot reasonably be carried out in relation to those premises without the vehicle being parked as such, and the vehicle is so parked for no longer than is necessary and for no more than 20 minutes

Where:

- the vehicle is being used in connection with any of the following:
  - undertaking any building operation, demolition or excavation
  - the collection of waste by a local authority
  - removing an obstruction to traffic
  - undertaking works in relation to a road, a traffic sign or road lighting
  - undertaking works in relation to a sewer or water main or in relation to the supply of gas, electricity, water or communications services
- it cannot be so used without being parked as such and
- it is so parked for no longer than is necessary

Where the vehicle is stopped, for no longer than is necessary, for the purpose of allowing people to board or alight from it

## **27 - Parked in a special enforcement area adjacent to a footway, cycle track or verge lowered to meet the level of the carriageway**

The contravention occurs when a vehicle waits on the carriageway, adjacent to the footway where the footway, cycle track or verge has been lowered to meet the level of the carriageway

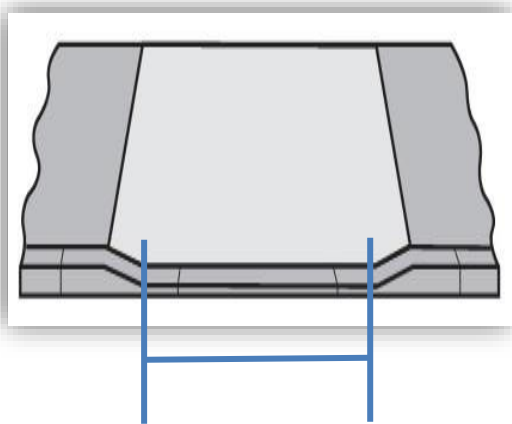
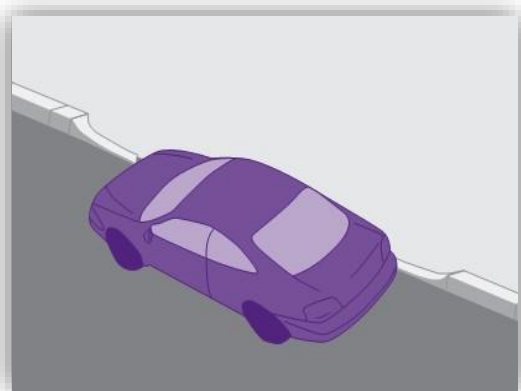

The contravention **only** occurs if any part of the vehicle is adjacent to the flat section of the dropped kerb- this does not include the angled sections of the kerb

### **Extra information to be recorded:**

- A diagram of the parking position, a photograph is preferable
- Details of any complaint received

### **Loading/unloading allowed:**

Yes

### **Observation period:**

Yes

### **Notes:**

A vehicle parked outside residential premises with its own drive requires a complaint before issuing with a penalty charge. All other drop kerbs: shared, business, crossings etc. do not

The contravention occurs if any part of the vehicle is parked adjacent to where the carriageway has been lowered for the purpose of:

- assisting pedestrians crossing the carriageway
- assisting cyclists entering or leaving the carriageway
- assisting vehicles entering or leaving the carriageway across the footway, cycle track or verge

## **27 - Exemptions to enforcement**

Where the vehicle is parked wholly within a designated parking place or any other part of the carriageway where parking is specifically authorised

Where the vehicle is parked outside residential premises by or with the consent (but not consent given for reward) of the occupier of the premises. This exception does not apply in the case of a shared driveway

Where the vehicle is being used for fire brigade, ambulance or police purposes

Where:

- the vehicle is being used for the purposes of delivering goods to, or collecting goods from, any premises, or is being loaded from or unloaded to any premises
- the delivery, collection, loading or unloading cannot reasonably be carried out in relation to those premises without the vehicle being parked as such, and the vehicle is so parked for no longer than is necessary and for no more than 20 minutes

Where:

- the vehicle is being used in connection with any of the following:
  - undertaking any building operation, demolition or excavation
  - the collection of waste by a local authority
  - removing an obstruction to traffic
  - undertaking works in relation to a road, a traffic sign or road lighting
  - undertaking works in relation to a sewer or water main or in relation to the supply of gas, electricity, water or communications services
- it cannot be so used without being parked as such and
- it is so parked for no longer than is necessary

Where the vehicle is stopped, for no longer than is necessary, for the purpose of allowing people to board or alight from it

*Section 86, Traffic Management Act 2004*



## **28 - Parked in a special enforcement area on part of the carriageway raised to meet the level of a footway, cycle track or verge**

The contravention occurs when a vehicle waits on the carriageway, adjacent to the footway where the carriageway has been raised to meet the level of the footway, cycle track or verge



### **Extra information to be recorded:**

A diagram of the parking position, a photograph is preferable  
Details of any complaint received

### **Loading/unloading allowed:**

Yes

### **Observation period:**

Yes

### **Notes:**

The contravention only occurs if the carriageway has been raised for the purpose of:

assisting pedestrians crossing the carriageway  
assisting cyclists entering or leaving the carriageway  
assisting vehicles entering or leaving the carriageway across the footway, cycle track or verge

## **28 - Exemptions to enforcement**

Where the vehicle is parked wholly within a designated parking place or any other part of the carriageway where parking is specifically authorised

Where the vehicle is being used for fire brigade, ambulance or police purposes

Where:

- the vehicle is being used for the purposes of delivering goods to, or collecting goods from, any premises, or is being loaded from or unloaded to any premises
- the delivery, collection, loading or unloading cannot reasonably be carried out in relation to those premises without the vehicle being parked as such, and the vehicle is so parked for no longer than is necessary and for no more than 20 minutes

Where:

- the vehicle is being used in connection with any of the following:
  - undertaking any building operation, demolition or excavation
  - the collection of waste by a local authority
  - removing an obstruction to traffic
  - undertaking works in relation to a road, a traffic sign or road lighting
  - undertaking works in relation to a sewer or water main or in relation to the supply of gas, electricity, water or communications services
- it cannot be so used without being parked as such and
- it is so parked for no longer than is necessary

Where the vehicle is stopped, for no longer than is necessary, for the purpose of allowing people to board or alight from it.

*Section 86, Traffic Management Act 2004*

## **30 - Parked longer than permitted**

The contravention covers a number of circumstances in which a vehicle waits for longer than the permitted period

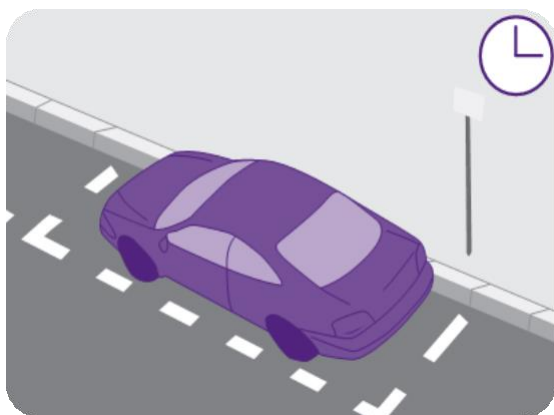

### **Extra information to be recorded:**

#### **1st observation:**

Time, VRM, Vehicle valve positions

#### **2<sup>nd</sup> observation:**

Valve positions to match those made in first observation

Maximum stay period

### **Loading/unloading allowed:**

No

### **Observation period:**

Yes

### **Suffixes:**

f = free parking bay

= Blue Badge holder

## **30 - Exemptions to enforcement**

Vehicles carrying out removals from domestic or commercial properties

Whilst displaying a valid Blue Badge

For as long as is necessary to pick up or set down passengers. The driver should remain with the vehicle unless evidence of assisting young or disabled passengers

When a valid dispensation is clearly displayed within the vehicle whilst the vehicle is parked within the confines granted

Royal Mail vehicles delivering or collecting items of post

Local Authority vehicles carrying out statutory duties

Vehicles considered to be parked for ambulance purposes, police purposes, or fire brigade purposes

Vehicles parked for the purpose of erecting or dismantling scaffolding

Vehicles being used in connection with works on the carriageway that constitutes an exemption under the New Road and Street Works Act (1991)

Any non-passenger vehicle being used for the purpose of any building operation, demolition or excavation adjacent to the parking place, the maintenance, improvement or reconstruction of the road or the cleansing of gullies in or adjacent to the parking place, the laying, erection, alteration, removal or repair in or adjacent to the parking place or any sewer or of any main, pipe or apparatus for the supply of gas, water or electricity or of any telecommunication apparatus as defined in the Telecommunications Act 1984 or the placing, maintenance or removal of any traffic sign

Vehicles clearly displaying a valid Health Emergency Badge in accordance with the conditions of use

## **40 - Parked in a designated disabled person's parking place without displaying a valid disabled person's badge in the prescribed manner**

The contravention occurs when a vehicle waits in an on-street disabled bay without displaying a valid blue badge in the correct manner

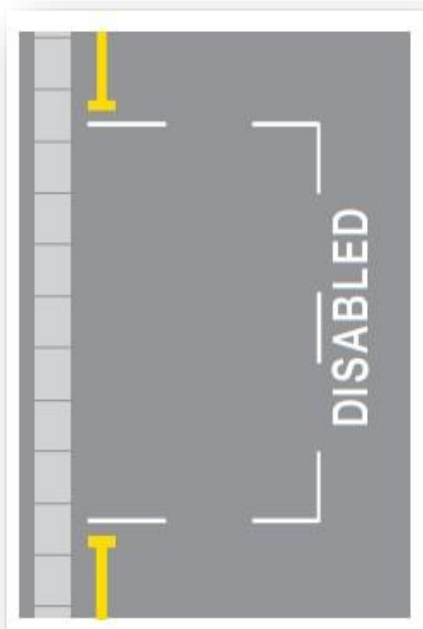

### **Extra information to be recorded:**

Details of any invalid badge

If face down serial number should be noted

### **Loading/unloading allowed:**

Yes

### **Observation period:**

Yes

### **Notes:**

Where time plate indicates a time limit clock must be used and correctly set

The old style Orange disabled badge signs became invalid in December 2010 and are no longer enforceable

## **40 - Exemptions to enforcement**

Vehicles parked in connection with loading/unloading activity. The maximum time permitted for this activity is 20 minutes. Any loading activity should be continuous and evident to the CEO during their observations

For as long as is necessary to pick up or set down passengers. The driver should remain with the vehicle unless evidence of assisting young or disabled passengers

When a valid dispensation is clearly displayed within the vehicle whilst the vehicle is parked within the confines granted

Royal Mail vehicles delivering or collecting items of post, under their universal postal license and as such still attract an exemption whereby there is no time limit

Vehicles considered to be parked for ambulance purposes, police purposes, or fire brigade

Vehicles parked for the purpose of erecting or dismantling scaffolding

Vehicles being used in connection with works on the carriageway that constitutes an exemption

Any non-passenger vehicle being used for the purpose of any building operation, demolition or excavation adjacent to the parking place, the maintenance, improvement or reconstruction of the road or the cleansing of gullies in or adjacent to the parking place, the laying, erection, alteration, removal or repair in or adjacent to the parking place or any sewer or of any main, pipe or apparatus for the supply of gas, water or electricity or of any telecommunication apparatus as defined in the Telecommunications Act 1984 or the placing, maintenance or removal of any traffic sign

Vehicles clearly displaying a valid Health Emergency Badge in accordance with the conditions of use

## 45 - Stopped on a Taxi Rank

The contravention occurs when a vehicle waits on a restricted taxi rank

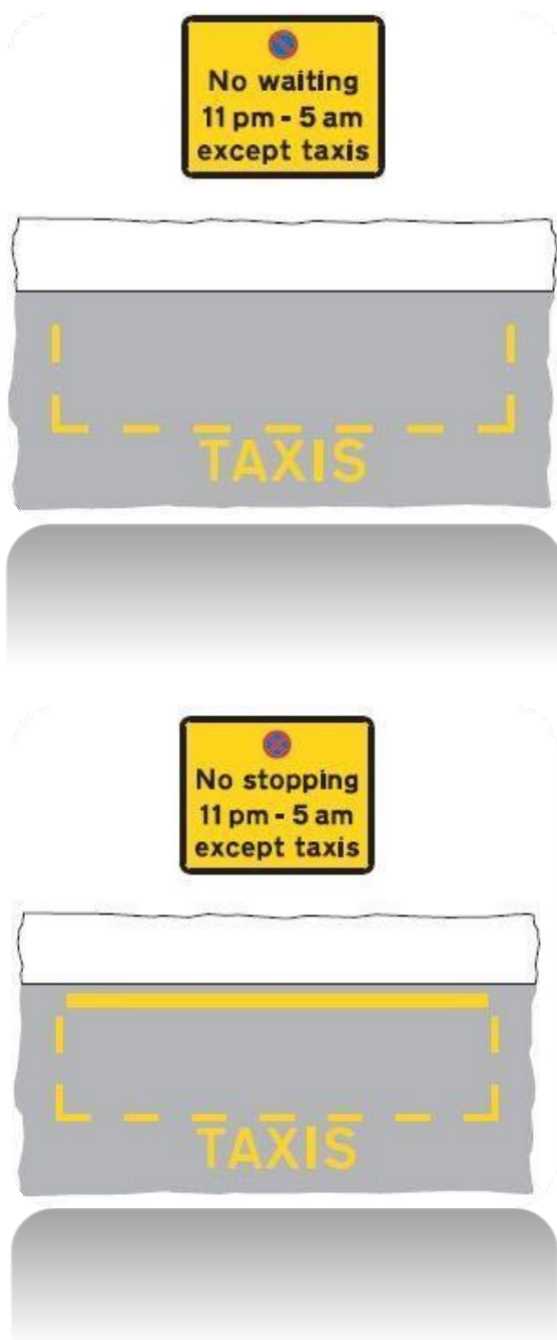

**Extra information to be recorded:**

None

**Loading/unloading allowed:**

Yes

**Observation period:**

Yes

**Notes:**

A taxi rank can be either a waiting, loading or stopping restriction depending on signage  
No loading requires kerb blips and no stopping a 20cm yellow line similar to a bus clearway

**Suffixes:**

## **45 - Exemptions to enforcement**

Taxi

Anything done with the permission or at the direction of a police officer in uniform, a traffic warden or a civil enforcement officer

Any person who causes or permits any vehicle to wait in accordance with any restriction or requirement indicated by traffic signs placed pursuant to Section 66 or Section 67 of the Road Traffic Regulation Act 1984

Any vehicle being used:

- for fire brigade, ambulance or police purposes
- for the purpose of exercising any statutory power or performing any statutory duty



## **47 - Stopped on a restricted bus stop or stand**

The contravention occurs when a vehicle stops on a restricted bus stop or stand clearway

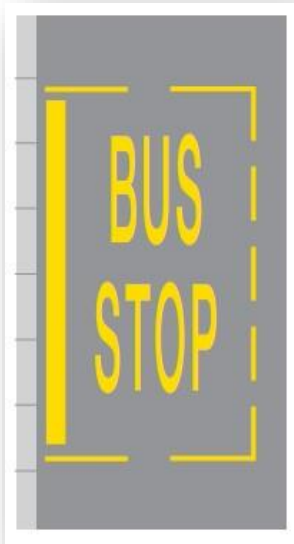

**Extra information to be recorded:**

None

**Loading/unloading allowed:**

No

**Observation period:**

No

**Notes:**

A bus for the purposes of a bus stop clearway means a bus operating a local scheduled service on behalf of TFL or a rail replacement service

Some bus stops in Merton are not restricted, the bus stop requires time plate, 20cm SYL and a yellow cage before it can be enforced

Taxi cabs can set down and pick up and alight passengers

**Suffixes:**

j = camera enforcements

## **47 - Exemptions to enforcement**

### Exceptions in favour of buses

A bus being used in the provision of a local service who causes the bus to stop within the clearway for so long as may be necessary:

- to maintain the published timetable for the service (provided, in the case of a bus stop clearway, the bus is not stopped within the clearway for a period exceeding two minutes)
- to enable passengers to board or alight from the bus
- to enable the crew of the bus to be changed

### Other exceptions

A vehicle being used for fire brigade, ambulance or police purposes

A taxi which is stationary only for so long as may be reasonably necessary for a passenger to board or alight and to load or unload any luggage of the passenger

A marked vehicle which, whilst used by Royal Mail in the course of the provision of a universal postal service, is stationary only for so long as may be reasonably necessary for postal packets to be collected

A vehicle driven by a person whilst being trained to drive a bus operating local services who, as part of his training, stops the vehicle within a clearway for no longer than necessary to simulate the stopping of a bus at a bus stop for the purpose of picking up and setting down passengers

A vehicle which is stationary in order that it may be used for one or more of the purposes specified below and which cannot be used for such a purpose without stopping in the clearway

### Permitted purposes

any operation involving building, demolition or excavation

the removal of any obstruction to traffic

the maintenance, improvement or reconstruction of a road

constructing, improving, maintaining or cleaning any street furniture including bus stop infrastructure

the laying, erection, alteration, repair or cleaning of any sewer or of any main, pipe or apparatus for the supply of gas, water or electricity, or of any telecommunications apparatus kept installed for the purposes of a telecommunications code system or of any other telecommunications apparatus lawfully kept installed in any position

*TSRGD 2002 Schedule 19*

## **48 - Stopped in a restricted area outside a school, a hospital or a fire, police or ambulance station when prohibited**

The contravention occurs when a vehicle stops on a restricted zig-zag during prescribed hours

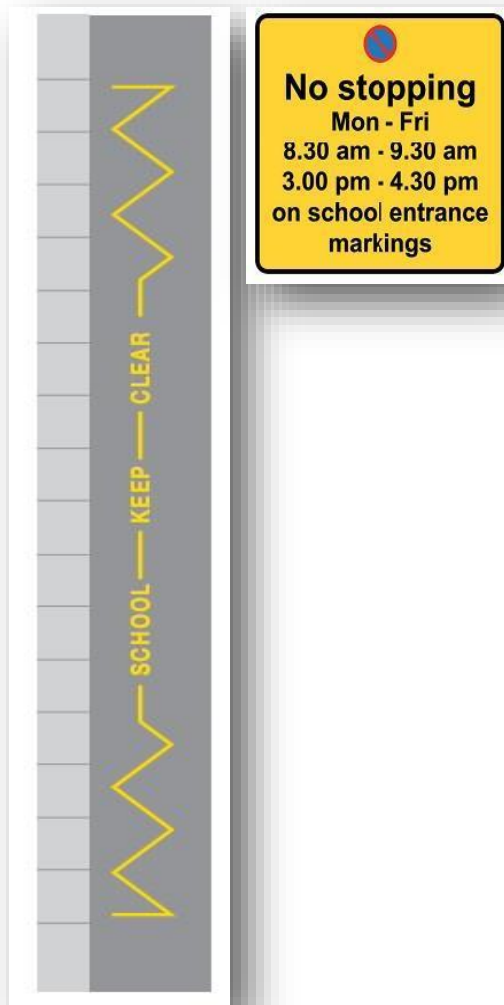

**Extra information to be recorded:**

None

**Loading/unloading allowed:**

No

**Observation period:**

No

**Notes:**

Current Council policy is to not enforce this restriction in the local state school holidays unless in a CPZ when an 01 should be used for the yellow line instead

Markings without time plate are advisory only

**Suffixes:**

j = camera enforcements

## **48 - Exemptions to enforcement**

Vehicles considered to be parked for ambulance purposes, Police purposes, or Fire brigade purposes

## **49 - Parked wholly or partly on a cycle track or lane**

The contravention covers a vehicle stops on a cycle track or lane where prohibited

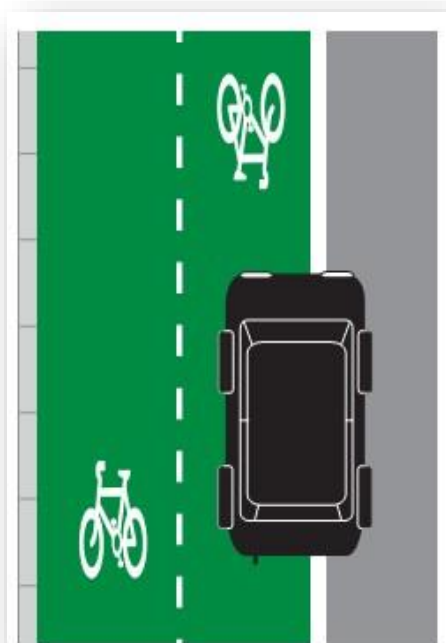
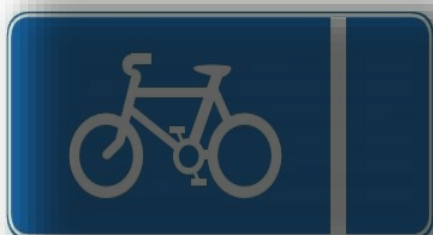

**Extra information to be recorded:**

None

**Loading/unloading allowed:**

Only in a cycle lane

**Observation period:**

Only in a cycle lane

**Notes:**

A cycle track is part of a highway for use only by pedal cycles, i.e. off the carriageway

A cycle lane is part of the carriageway and is marked by a solid white line, cycle logos and roadside signage

Parking in an advisory cycle lane marked with a broken white line is not in contravention

If the lane is marked with yellow lines codes 01 or 02 should be used as appropriate

**Suffixes:**

none

## **49 - Exemptions to enforcement**

The vehicle was parked in contravention for the purpose of saving life, or extinguishing fire or meeting any other like emergency

The vehicle was owned or operated by a highway authority or by a person discharging functions on behalf of a highway authority and was parked in contravention in connection with the carrying out by or on behalf of that authority of any of the following, that is, the cleansing, maintenance or improvement of, or the maintenance or alteration of any structure or other work situated in, the cycle track or its verges or the preventing or removing of obstructions to the cycle track or the preventing or abating in any other way of nuisances or other interferences with the cycle track

The vehicle was owned or operated by statutory undertakers and was parked in contravention in connection with the carrying out by those undertakers of any works in relation to any apparatus belonging to or used by them for the purpose of their undertaking

*Section 21 Road Traffic Act 1988*

## **55 - A commercial vehicle parked in a restricted street in contravention of the Overnight Waiting Ban**

The contravention occurs when a commercial vehicle over the indicated max gross weight of 5 tonnes (excluding passenger carrying vehicles designed to carry fewer than 13 passengers) waits in a restricted street overnight between 6.30pm-8.00am.

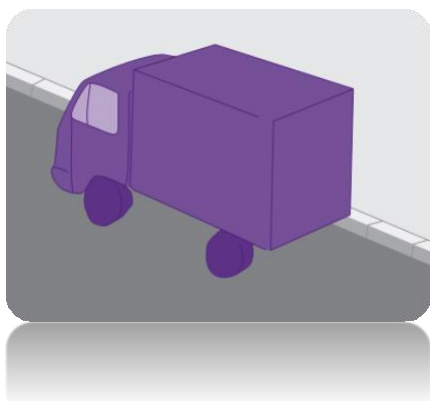

### **Extra information to be recorded:**

Details of type and size of vehicle and Max gross weight if shown  
Location of nearest sign

### **Loading/unloading allowed:**

Yes

### **Observation period:**

Yes

### **Notes:**

Street is 'restricted' if it contains the correct sign somewhere in the street  
Identification of a 5t+ vehicle is not always easy checking tax disc, operator's licence, rear markings sometimes helps if in doubt check with the office

### **Suffixes:**

none



## **55 - Exemptions to enforcement**

The vehicle is considered to be parked for ambulance, police or fire brigade purposes

For as long as is necessary to pick up or set down passengers. The driver should remain with the vehicle. If upon further observation the CEO identifies that the vehicle remains in situ after the picking up/setting down activity has ceased, a PCN may be issued

Any non-passenger vehicle being used for the purpose of any building operation, demolition or excavation adjacent to the parking place, the maintenance, improvement or reconstruction of the road or the cleansing of gullies in or adjacent to the parking place, the laying, erection, alteration, removal or repair in or adjacent to the parking place or any sewer or of any main, pipe or apparatus for the supply of gas, water or electricity or of any telecommunication apparatus as defined in the Telecommunications Act 1984 or the placing, maintenance or removal of any traffic sign

## **61 - A heavy commercial vehicle wholly or partly parked on a footway, verge or land between two carriageways**

The contravention occurs when a HGV over 7.5 tonne parks on the footway or central reservation



### **Extra information to be recorded:**

Number of wheels on the footway

Diagram or photograph of the parking position

### **Loading/unloading allowed:**

Yes, but only if it is essential and cannot be carried out elsewhere

### **Observation period:**

If essential as described above, then yes

### **Notes:**

This contravention applies nationally to vehicles of more than 7.5 tonnes, as defined in Section 20 of the Road Traffic Act 1988. Unlike code 62 it is enforced borough wide with no exceptions.

### **Suffixes:**

1) wheel, 2) partly on footway, 4) all wheels on footway

c = on vehicle crossover

g = on grass verge

## **61 - Exemptions to enforcement**

Vehicle was parked in accordance with permission given by a constable in uniform

Vehicle was parked in contravention of this section for the purpose of saving life or extinguishing fire or meeting any other like emergency

The vehicle was parked on the verge of a road or on a footway for the purpose of loading or unloading, and that the loading or unloading of the vehicle could not have been satisfactorily performed if it had not been parked on the footway or verge that the vehicle was not left unattended at any time while it was so parked

*Road Traffic Act 1988 section 19*

## **62 - Parked with one or more wheels on or over a footpath or any part of the road other than a carriageway**

The contravention occurs when a vehicle waits on any part of a footpath, footway or other part of a road that is not carriageway

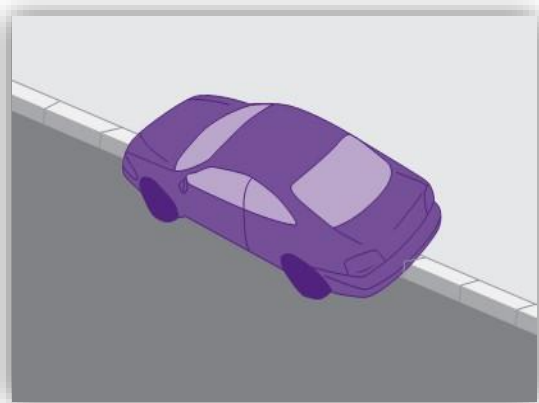

### **Extra information to be recorded:**

Number of wheels on the footway

Diagram or photograph of the parking position

### **Loading/unloading allowed:**

Yes, but only if it is essential so as not to cause an obstruction and cannot be carried out elsewhere and the vehicle is not left unattended.

### **Observation period:**

If essential as described above, then yes

### **Notes:**

Footway parking is allowed where signs and markings officially authorise it'

### **Suffixes:**

1, 2, 3 or 4 = wheel on footway

c = on vehicle crossover

g = on grass verge

## **62 - Exemptions to enforcement**

Vehicle is parked in accordance with permission given by a constable in uniform; or the purpose of saving life or extinguishing a fire or meeting any other emergency; or for the purpose of rendering assistance at the scene of an accident or a bona fide breakdown involving one or more vehicles, and

- such assistance could not have been safely or satisfactorily rendered if the vehicle had not been so parked; and
- the vehicle was not left unattended at any time while it was so parked;

The vehicle is parked for the purpose of loading or unloading goods, and

- the loading or unloading of the vehicle could not have been satisfactorily performed if it had not been so parked; and
- the vehicle was not left unattended at any time while it was so parked.

A vehicle of any of the following descriptions, that is to say:

- vehicles used for fire brigade purposes;
- vehicles used for police purposes;
- vehicles used for ambulance purposes;
- street cleansing purposes;
- vehicles used for the collection of refuse;
- vehicles used for the purpose of gritting or salting or the clearance of snow;
- vehicles used for the purpose of cleansing, repairing or maintaining lighting apparatus;
- vehicles used in connection with the reconstruction, alteration or maintenance of, or the provision of services to, a road, or of or to any premises adjoining a road; (ix) vehicles used in connection with the placing, inspecting, maintaining, adjusting, repairing, altering, renewing or removing of apparatus or accommodation therefore in, under or over a road;
- any vehicle not falling within sub-paragraph (viii) or (ix) of this paragraph used by statutory undertakers in pursuance of their statutory powers or duties provided that is reasonably necessary for the vehicle to be so parked;
- vehicles of any class for the time being specified by resolution of the Council for the purposes of this subsection;

- any vehicle, specified by the highway authority from time to time for the purposes of this subsection, which is parked at such place and at such time as may be authorised by that highway authority.

*Greater London (General Powers) Act 1974 as amended by the London Local Authorities and Transport for London Act 2008*

## **99 - Stopped on a pedestrian crossing or crossing marked by zigzags**

The contravention occurs when a vehicle stops on a pedestrian crossing marked by zigzags

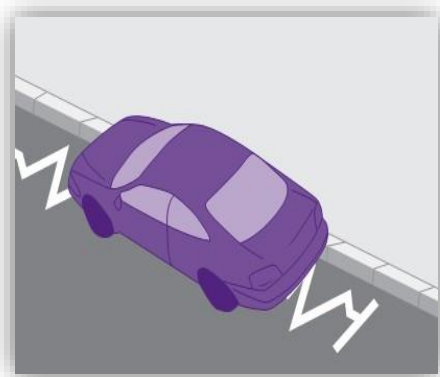
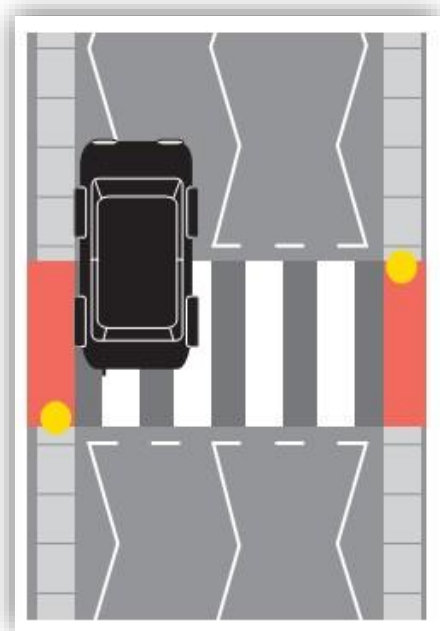

**Extra information to be recorded:**

None

**Loading/unloading allowed:**

No

**Observation period:**

If essential as described above, then yes

**Notes:**

None

**Suffixes:**

## **99 - Exemptions to enforcement**

The driver has stopped it for the purpose of allowing pedestrians to cross

The driver is prevented from proceeding by circumstances beyond his control or it is necessary for him to stop to avoid injury or damage to persons or property

The vehicle is being used for police, fire brigade or ambulance purposes

The vehicle is stopped in the controlled area:

- for so long as may be necessary to enable the vehicle to be used for the purposes of:

kept installed in any position, but only if the vehicle cannot be used for one of those purposes without stopping in the controlled area any building operation, demolition or excavation

the removal of any obstruction to traffic

the maintenance, improvement or reconstruction of a road

the laying, erection, alteration, repair or cleaning in or near the crossing of any sewer or of any main, pipe or apparatus for the supply of gas, water or electricity, or of any telecommunications apparatus kept installed for the purposes of a telecommunications code system or of any other telecommunications apparatus lawfully

if the vehicle is a public service vehicle being used:

- in the provision of a local bus service
- to carry passengers for hire or reward at separate fares, and the vehicle, having proceeded past the crossing to which the controlled area relates, is waiting in that area in order to take up or set down passengers

if he stops the vehicle for the purpose of making a left or right turn

*The Zebra, Pelican and Puffin Pedestrian Crossings Regulations and General Directions 1997*



# Off-Street contraventions (updated Sep-17)

## 82 - Parked after the expiry of paid for time

The contravention occurs when a vehicle parks in a car park displaying an expired ticket

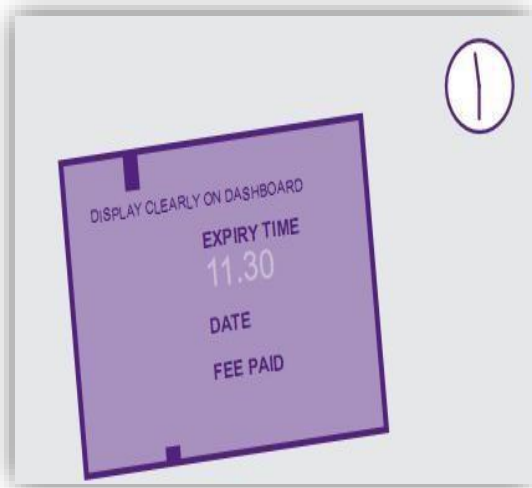

**Extra information to be recorded:**

- Ticket details
- Machine clock checked

**Loading/unloading allowed:**

- 10 Minutes after expiry of paid for time

**Observation period:**

- None

**Notes:**

- A PCN should not be issued until at least 10 minutes has elapsed since ticket expiry time

**Suffixes:**

- None
- u – electronic payment

## **83 - Parked in a car park without clearly displaying a valid pay & display ticket or voucher or parking clock**

The contravention occurs when a vehicle parks in a car park without clearly displaying a valid ticket or permit

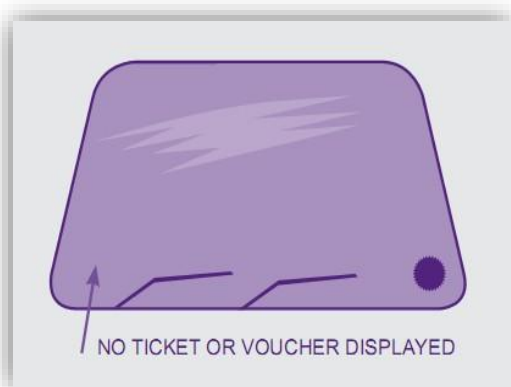

### **Extra information to be recorded:**

- Machine checked
- No driver seen
- No electric payment

### **Loading/unloading allowed:**

No

### **Observation period:**

No after checking machines

### **Notes:**

None

### **Suffixes:**

None

## **84 - Parked with payment made to extend the stay beyond initial time**

The contravention occurs when a vehicle remains in a parking bay off street beyond the time that was initially purchased by displaying a further ticket



### **Extra information to be recorded:**

#### **1st observation:**

- Time of observation
- VRM
- P&D ticket details
- Vehicle valve positions
- Electronic payment

#### **2nd observation (after initial expiry time):**

- Valve positions to match those made on first observation
- Details of extra ticket purchased
- Max stay of bay
- Electronic payment

### **Loading/unloading allowed:**

Not applicable

### **Observation period:**

None required at second observation

### **Notes:**

Merton policy permits meter feeding unless: 1) Max stay is exceeded 2) Driver gains financially due to tariff change

Suffixes:

## **86 - Not parked correctly within the markings of a bay or space**

The contravention occurs when a vehicle parks off street wholly or partly outside a marked bay

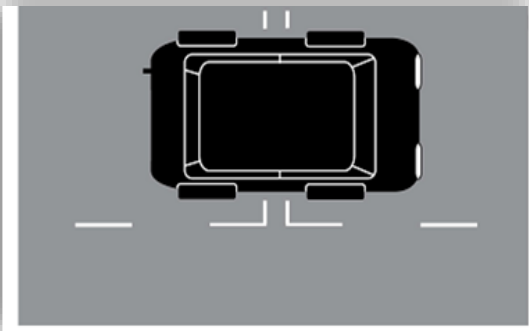
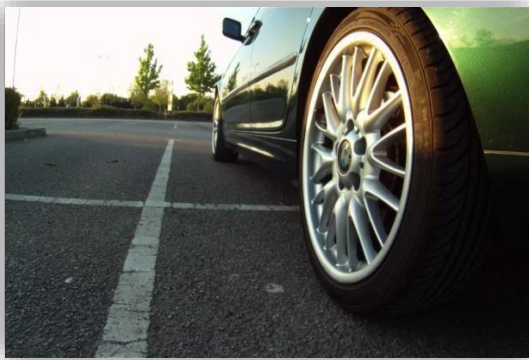

**Extra information to be recorded:**

P&D Ticket details

Photo or drawing of position of car

**Loading/unloading allowed:**

No

**Observation period:**

None

**Notes:**

Due to position of the pillars adjacent to the bays in St Georges car park careful consideration should be given before issuing

If completely out of bay but not causing an actual obstruction to other users then this code should be used

**Suffixes:**

None

## **85 - Parked without clearly displaying a valid permit where required**

The contravention occurs when a vehicle parks in a permit bay without displaying the correct permit for that bay as shown on the sign



### **Extra information to be recorded:**

- P&D Ticket details
- Wrong type of permit
- Bay number if marked
- Photo of signage

### **Loading/unloading allowed:**

No

### **Observation period:**

None

### **Notes:**

Due to position of the pillars adjacent to the bays in St Georges car park careful consideration should be given before issuing

If completely out of bay but not causing an actual obstruction to other users then this code should be used

### **Suffixes:**

None

## **87 – Parked in a designated disabled person’s parking place without displaying a valid disabled person’s badge in the prescribed**

The contravention occurs when a vehicle parks in a designated disabled bay in a car park without displaying a valid Blue Badge



### **Extra information to be recorded:**

- Any invalid badge
- Bay number if marked
- Serial number if face down badge
- Photo of signage

### **Loading/unloading allowed:**

No

### **Observation period:**

None

### **Notes:**

Restriction is only enforceable during charged hours

Signage does not have to comply with TSRGD but should be clear such as legend on road or wall mounted signs

### **Suffixes:**

None

## **90 - Re-parked in a car park within one hour after leaving**

The contravention occurs when a vehicle re parks in a car park within 1 hour where prohibited

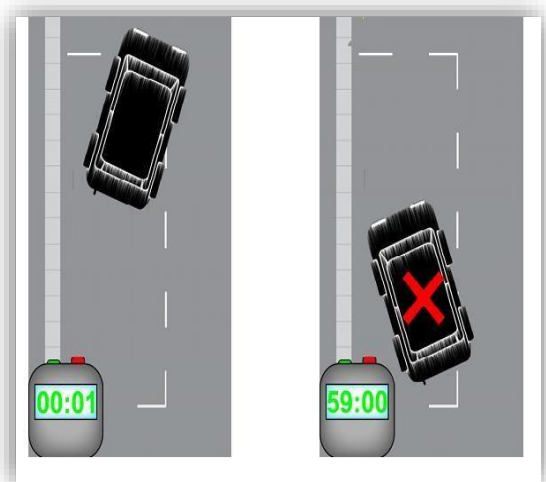
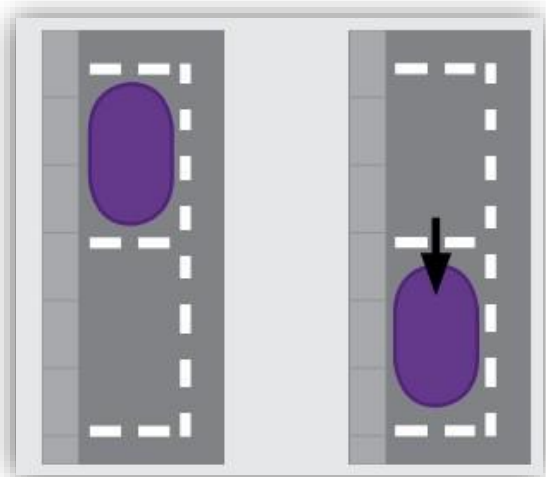

### **Extra information to be recorded:**

Details of the first observation

P&D ticket details

1<sup>st</sup> and 2<sup>nd</sup> bay numbers

Electronic payment

### **Loading/unloading allowed:**

No

### **Observation period:**

None after first observation

### **Notes:**

Only to be used if the driver has gained financially from moving/leaving and re-parking or over stayed maximum stay i.e. Peel House Lower

Contravention is re-parked within one hour of LEAVING and not ticket expiry, therefore 2<sup>nd</sup> P&D must have been purchased within 1 hour of first log

### **Suffixes:**

None

## **91 - Parked in a car park or area not designated for that class of vehicle**

The contravention occurs when a vehicle parks in a bay or car park not for that class of vehicle

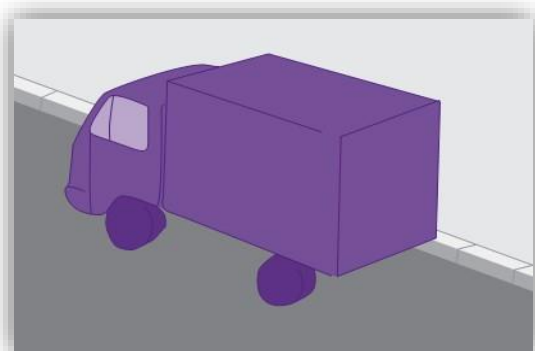
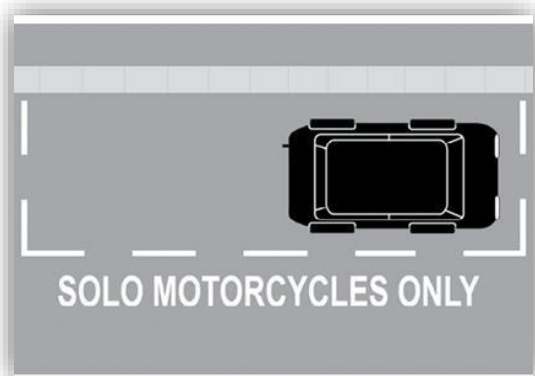

### **Extra information to be recorded:**

Type of bay

Photo of signage

Class of vehicle parked

### **Loading/unloading allowed:**

No

### **Observation period:**

None

### **Notes:**

Examples:

Car parked in M/C bay

HGV parked in car park where prohibited

### **Suffixes:**

None



## **92 - Parked in a car park causing an obstruction**

The contravention occurs when a vehicle parks in a car park causing an obstruction to other users



### **Extra information to be recorded:**

Details of the obstruction

### **Loading/unloading allowed:**

No

### **Observation period:**

None

### **Notes:**

A PCN can only be issued on this code if an actual obstruction has taken place e.g. an exit or another vehicle is obstructed or a suspended bay is occupied by the offending vehicle.

If a vehicle is outside a marked bay but is not causing an actual obstruction (as above) then code 86 should be used.

If parked on a yellow line or hatch markings and is not causing an obstruction to other users then code 86 should be used.

### **Suffixes:**

o = blue badge

## Contravention codes (version 6.7.3)

Code	General suffix(es)	Description	Different level
01	aoyz	Parked in a restricted street during prescribed hours	Higher
02	ao	Parked or loading / unloading in a restricted street where waiting and loading / unloading restrictions are in force	Higher
05	cpsuv1	Parked after the expiry of paid for time	Lower
06	cipv1	Parked without clearly displaying a valid pay & display ticket or voucher	Lower
07	cmprsv	Parked with payment made to extend the stay beyond initial time	Lower
12	rstuwy	Parked in a residents' or shared use parking place or zone without either clearly displaying a valid permit or voucher or pay and display ticket issued for that place, or without payment of the parking charge	Higher
14		Parked in an electric vehicles charging place during restricted hours without charging.	Higher
16	bdehqstwxyz	Parked in a permit space or zone without clearly displaying a valid permit	Higher
19	irsuwxyz	Parked in a residents' or shared use parking place or zone either displaying an invalid permit or voucher or pay and display ticket, or after the expiry of paid for time	Lower
21	bcdefghlmpqrsuv12	Parked wholly or partly in a suspended bay or space	Higher
22	cflmnopsv	Re-parked in the same parking place or zone within one hour after leaving	Lower
23	bcdefghklprsv12	Parked in a parking place or area not designated for that class of vehicle	Higher
24	bcdefhlmpqrsv12	Not parked correctly within the markings of the bay or space	Lower
25		Parked in a loading place during restricted hours without loading	Higher
26		Parked in a special enforcement area more than 50 cm from the edge of the carriageway and not within a designated parking place	Higher
27	o	Parked in a special enforcement area adjacent to a footway, cycle track or verge lowered to meet the level of the carriageway	Higher
28	o	Parked in a special enforcement area on part of the carriageway raised to meet the level of a footway, cycle track or verge	Higher

30	flmnopsu	Parked for longer than permitted	Lower
40		Parked in a designated disabled person's parking place without displaying a valid disabled person's badge in the prescribed manner	Higher
45		Parked on a taxi rank	Higher
47	j	Stopped on a restricted bus stop or stand	Higher
48	j	Stopped in a restricted area outside a school, a hospital or a fire, police or ambulance station when prohibited	Higher
49		Parked wholly or partly on a cycle track or lane	Higher
55		A commercial vehicle parked in a restricted street in contravention of the Overnight Waiting Ban	Higher
61	124cg	A heavy commercial vehicle wholly or partly parked on a footway, verge or land between two carriageways	Higher
62	124cg	Parked with one or more wheels on or over a footpath or any part of a road other than a carriageway	Higher
99	o	Stopped on a pedestrian crossing or crossing area marked by zigzags	Higher
82	puv	Parked after the expiry of paid for time	Lower
83		Parked in a car park without clearly displaying a valid pay & display ticket or voucher or parking clock	Lower
84	u	Parked with payment made to extend the stay beyond initial time	Lower
86	prs	Not parked correctly within the markings of a bay or space	Lower
87		Parked in a designated disabled person's parking place without displaying a valid disabled person's badge in the prescribed manner	Higher
90	psuv	Re-parked in the same car park within one hour after leaving	Lower
91	cg	Parked in a car park or area not designated for that class of vehicle	Higher
92	o	Parked causing an obstruction	Higher

# Suffixes

## **General suffixes:**

- |                            |                            |
|----------------------------|----------------------------|
| a) Temporary traffic order | b) Business day            |
| c) Buses only Car          | d) Doctor's bay            |
| e) club bay Motor          | f) Free parking bay        |
| g) cycle bay               | h) Hospital bay            |
| i) Wrong type of voucher   | j) Camera enforcement      |
| k) Ambulance bay           | l) Loading place           |
| m) Parking meter           | n) Red route               |
| o) Blue badge holder       | p) Pay & display           |
| q) Market trader's bay     | r) Resident's bay          |
| s) Shared use bay          | t) Mobile phone parking    |
| u) Voucher                 | v) Wrong parking zone      |
| w) Incorrect VRM           | x) Obscured/illegal permit |
| y) Out of date permit      |                            |

## **Footway parking (codes 61, 62) only:**

- 1) One wheel on footway
- 2) Partly on footway
- 4) All wheels on footway
- c) On vehicle crossover
- g) On grass verge